



Always with our customers

www.hynux.com

Always With Our Customers

WORLD LEADER IN CONTROL & MEASUREMENT

PRODUCT GUIDE



HANYOUNG NUX

Since 1972

























SHANGHAI HANYOUNG ELECTRONICS CO., LTD



PT. HANYOUNG ELECTRONIC INDONESIA



CONTENTS

	Temperature Controller	4 page
	Recorder	40 page
	Digital Counter/Timer	42 page
	Analog Timer	51 page
	Multi Pulse Meter	55 page
	Panel Meter	57 page
	Proximity Sensor	63 page
	Photo Sensor	76 page
	Rotary Encoder	94 page
	Thyristor Power Regulator	98 page
	Solid State Relay	108 page
	Power supply	119 page
	Control Switch / Combination display light	122 page
	Power / Main / Cam Switch	128 page
	Limit Switch	131 page
	Micro Switch	133 page
	Hoist / Foot Switch / Mono Lever Switch	134 page
	Sign Tower	137 page
	Cube Tower	142 page
	Wall Mounted Light	142 page
	Turn Light	144 page
	Warning Light	147 page
	Terminal Block, Power Buzzer, Fuse Holder, Control Box	148 page

Temperature Controller

TD510 Programmable temperature controller

Specification

Model	TD510		
Appearance			
W×H×D (mm)	145× 145× 33,5		
Power voltage	100 - 240 V a.c. Voltage regulation ±10 %		
Power frequency	50 - 60 Hz		
Power consumption	30 V A max		
Dielectric strength	Between 1st and 2nd terminals : Min, 1500 V a.c for 1 min Between 1st and FG terminals : Min, 1500 V a.c for 1 min Between 2nd and FG terminals : Min, 1500 V a.c for 1 min		
Input type	2 types of thermoresistor (Pt-100, KPt-100) ±0.1 % of FS ±1 Digit 11 types of thermocouple (K, J, E, T, R, B, S, L, N, U, Wire 5-26) ±0.1 % of FS ±1 Digit 4 types of DC voltage (-10 - 20 mV, 0 - 100 mV, 1 - 5 V, 0 - 30 V) ±0.1 % of FS ±1 Digit		
Sampling cycle	250 ms		
Contact output(DO)	Up to 32 relay	A Contact	30 V d.c. 3 A max, 250 V a.c. 3 A
		B Contact	NO : 30 V d.c. 5 A max, 250 V a.c. 5 A
Control output	SSR output	ON : 18 V d.c. Pulse voltage(800 Ω or more load resistance)	
	SCR output	4 - 20 mA d.c. (600 Ω or less load resistance)	
Transmission output	Current output	4 - 20 mA d.c.	
	Load resistance	600 Ω or less load resistance	
	Output type	Specific value(PV), Setting value(SV), Output(MV)	
	Refresh interval	250 ms	
Input	Input calibration (Sensor bias)	2 temperature points : EUS(0 - 100 %)	
	Scaling	DC voltage(VDC) : Input scaling according to conversion range	
	Input filter(LPF)	0 ~ 120 sec	
Control mode	Operation type	Constant-value / Program control	
Control output	Temperature control output	SSR output or SCR (4 - 20 mA d.c.) output	
Control operation	Pattern	100 patterns(1 pattern/100 segments)	
	Segment	2,000 segments	
	PID Group	4 groups (Each channel)	
	Auto tuning	Auto tuning according to target setting value	
	Proportional band	0.00 - 100.00 % (For 0.00 %, ON/OFF control)	
	Integral time	0.0 ~ 3,000 sec (OFF when 0 sec)	
	Derivative time		
ON/OFF control	Set 0.0 to proportional band(PB)		
Transmission output	Temperatre(Ch.1 and 2)	4 - 20 mA d.c., Specific value(PV), Setting value(SV) and Output(MV)	
	Scaling	Auto scaling for defined upper/lower, limit range(4 - 20 mA d.c.)	
Alarm setting	Alarm setting	System alarm : 8 points, Assign 4 of 8 pattern alarms to a pattern	
	Alarm type	Absolute upper/lower limit, Offset upper/lower limit and Within/Out of range	
	Absolute alarm setting range	EU (0 ~ 100 %)	
Display	TFT color LCD (115,2 × 86,4 mm)		
Number of Pixels	640 × 480 pixel		
Back light	LED back light		
Life cycle of back light	Approx. 40,000 h		
Touch type	Resistive type (4 Wires)		
Language	Korean/English/Chinese(Simplified)		
Internal memory	Non-volatile memory : 80 MB - Saving of 15 days at 1 S interval		
External memory	SD card(2 GB) : Saving of 1 year at 1 S interval		
Saving interval	1 - 360 S		
Memory information	Program information, setting value, recovery, and temperature setting / specific / output value		
Ambient temperature	0 ~ 50 °C		
Ambient humidity	20 ~ 90 % RH (Without condensation)		
Weight	Approx. 1.32 kg		

Temperature Controller

Suffix Code

Model	Code	Information
TD	<input type="checkbox"/> 1 <input type="checkbox"/> - <input type="checkbox"/> <input type="checkbox"/> <input type="checkbox"/>	Programmable temperature controller
Display device	5	5.7" TFT-LCD
Channel	1	1 Channel
	2	2 Channel
Input/output	1	8 input points/6 output points(1 module)
	2	8 input points/14 output points(2 modules)
	3	16 input points/16 output points(3 modules)
Language	S	Korean, English, and Chinese(Simplified)
	T	Korean, English, and Chinese(Traditional)
Communication	None	RS485
	E	RS485, Ethernet(OS)

※ Basic components (Power module, Control module)

※ This product consists of the display and control (Power, Control, Input, and Output Modules). (Up to 32 contact input/output points, respectively)

Components

Product	Model	Information
Display	TD510-DISPLAY	Display (5.7" TFT LCD)
Control module	TD510-MAIN	Temperature 2-channel control module
Power module	TM-PWR	Power module
Input module	TM-DI	Module with 16 input points
Output module	TM-DO	Module with 8 output points
Input/output module	TM-DIO	Module with 8 input and 6 output points

TD500 Programmable temperature controller

Specification

Model	TD500			
Appearance				
W×H×D(mm)	183×144×103			
Power supply	100 – 240 V a.c. (±10 %), 50 – 60 Hz 16 W max.			
Screen	LCD	5.7 inch color / Touch panel type		
Program	Pattern / Segment	100 patterns / 2400 segments, Pattern repetition : 999 times max., Partial repetition : 255 max.		
Input	Measuring range	Sensor type Pt 100 Ω(IEC751) T.C (K, J, E, T, R, S) V DC (Voltage Input : 0 – 10 V, 1 – 5 mV, -10 – 20 mV, 0 – 100 mV Current Input : 1 – 5 V d.c. (4 – 20 mA d.c., attach 250 Ω external resistance)	Accuracy ±0.1 % of FS ±0.1 % of FS ±0.1 % of FS	Measuring range - 200.0 ~ 640.0 °C - 200.0 ~ 1700.0 °C 0.0 ~ 10.0 V (Range setting)
	Sampling cycle	500 ms		
Output	Control output	2 points for each channel (Heating / Cooling)		
	Specification	Voltage pulse (SSR) : 24 V d.c., minimum pulse width 10 ms Current (SCR) : 4 – 20 mA d.c.(Below 600 Ω) Relay output : N/O 250 V a.c. 5 A/ 30 V d.c. 5 A, N/C : 250 V a.c. 2 A/ 30 V d.c., TR output (O/C) : Max. 24 V 100 mA Sink		
Communication	Protocol	PC – Link(Check Sum), Modbus – ASCII		
	Communication Type	RS232C : 2400 ~ 115,200 bps Max. 10 m, RS422/485 : 2400 ~ 115,200 bps, Max.1.5km 256 Mode		

Suffix Code

Model	Code	Information
TD500	<input type="checkbox"/> <input type="checkbox"/> <input type="checkbox"/>	Programmable Temperature Controller
Types	1	Communication (RS485/422 Communication, USB)
	2	Communication (RS232 Communication, USB)
	N	None (Only when need the I/O (Input/Output board))
Input-Output board	1	Contact input (DI) 8 contacts Contact output (DO) 8 contacts Transistor output (DO) 8 contacts
	N	Non (Only necessary standard body)
Language		Korean/English (Standard type)
	2	English/Chinese (Simplified Chinese character)

Temperature Controller

TD300 Programmable temperature controller

Specification

Model	TD300
Appearance	
W×H×D (mm)	96×96×100
Program	Touch panel, 100 patterns (2,400 segments), 100 segments/1pattern setting
Screen	TFT LCD 70.08 × 52.56 mm (3.5")
Function	Contact input (D.I) : 8 contacts, Output (D.O) : 8, RS232/485
Power voltage	100 – 240 V a.c. 50 – 60 Hz (Voltage variation rate ±10 %)
Input	TC(K, J, E, T, R, S), VDC(0 – 100 mV, 0 – 10 V)
Input cycle	500 ms
Display accuracy	±0.1 % of FS
Output	Control output : SSR 24 V d.c. / SCR 4 – 20 mA d.c., Retransmission output : 4 – 20 mA d.c.
Control type	PID automatic tuning

Suffix Code

Model	Code	Information
TD300	<input type="checkbox"/> <input type="checkbox"/>	Programmable Temperature Controller (DIN 96 × 96)
Communication	1	RS485/422 communication
	2	RS232C communication
Language (Optional)	1	Korean and English (Standard type)
	2	English and Chinese (Simplified Chinese Characters)

TH300 Programmable temperature & Humidity controller

Specification

Model	TH300
Appearance	CE 
W×H×D (mm)	96×96×100
Program	Touch panel, 100 patterns (2,000 segments), 100 segments / 1pattern setting
Screen	TFT LCD 70.08 × 52.56 mm (3.5")
Function	Contact input (DI) : 4 contacts, Output (DO) : max 12, RS232/485
Power voltage	100 – 240 V a.c. 50 – 60 Hz (Voltage variation rate ±10 %)
Input	Pt100 Ω or 0 – 5 V d.c.
Input cycle	500 ms
Display accuracy	Temperature (°C) : ±0.2 % of FS Humidity (%RH) : ±2 % of FS
Output	Control output : SSR 24 V d.c. pulse, Retransmission output : 4 – 20 mA d.c.
Control type	PID automatic tuning

Suffix Code

Model	Code	Information
TH300	<input type="checkbox"/> <input type="checkbox"/>	Programmable Temperature & Humidity controller (DIN 96 × 96)
Communication	1	RS232C communication
	2	RS485/422 communication
Language (Optional)	1	Korean and English (Standard type)
	2	English and Chinese (Simplified Chinese Characters)
	3	English and Chinese (Traditional Chinese Characters)

Temperature Controller

TH500 Programmable temperature & Humidity controller

Specification

Model	TH500	
Appearance		
W×H×D (mm)	183× 144× 93,5	
Program	Max. 100 pattern (Max. 6,000 segment)	
Screen	5.7 inch STN color LCD screen (Touch screen type)	
Function	Pattern repetition : Max. 999 times, Partial repetition : Max. 255 times / Pattern link and editing	
Power voltage	100 – 240 V a.c., 50 – 60 Hz (Voltage variation rate : ±10 %)	
Input	Pt 100 Ω, 0(1) – 5 V d.c. or 4 – 20 mA d.c. (External resistance 250 Ω)	
Input cycle	500 ms	
Measuring range	Temperature	–100.00 ~ 200.00 °C
	Humidity	0.0 ~ 100.0 % RH
Display accuracy	Temperature : ±0.1 % of F.S. Humidity : ±1 % of F.S	
Control output	SSR output	Min. 24 V d.c. (Minimum pulse width : 0.2ms)
	Current output	4 – 20 mA d.c.
Retransmission output	Temperature : 1 point, Humidity : 1 point (PV, SV, MV selection) 4 – 20 mA Resistive Load Max. 600 Ω	
Contact input	D.I : 8 points	
Output	Max. 20 points (Relay : 12 points, Open collector : 8 points)	
Contact output type	Inner signal : 8 points, Alarm signal : 4 points each channel, Run/Stop signal : 1 point, 1st Ref. signal : 1 point, 2nd Ref. signal : 1 point Temp. / Humi. Up/Down, Soak signal : 6 points, Temp./Humi. Control signal : 2 points, Time signal : 8 points / 1 segment	
	Error signal : 1 point, Sensor disconnection signal : 1 point, Wait signal : 1 point, Hold signal : 1 point, PT End signal : 1 point	
Communication output	RS485–Max. communication distance 1.2 km, Max. 32 connections available, Communication speed : Max. 115,200 bps	
	RS 232, RS422/485	
Storage / Capacity	Internal FLASH memory, Temp./Humi. Each 86,400 points	
Storage function	Program information & Setting value back-up and recovery, Temp. / humi. Setting, Indicating value storage	
Ambient Temp. / Humidity	0 ~ 50 °C, 10 ~ 90 % RH (No condensation)	

Suffix Code

Model	Code	Information
TH500–	<input type="checkbox"/> <input type="checkbox"/> <input type="checkbox"/>	Programmable temperature & humidity controller
Types	1	Standard type Temperature&Humidity Retransmission output Temperature&Humidity control output (SSR/SCR drive) Temperature&Humidity signal input External digital input (DI) : 8 contacts Digital output (DO) : relay 12 contacts, open collector 8 contacts Communication specification: RS232, RS422/485, USB
	2	Additional type ※ Input and output boards are separated from the main body. Temperature/Humidity Retransmission output Temperature/Humidity signal input Communication specification: RS232, RS422/485 2CH, USB (PV Backup)
	N	– No body part
Additional type board (optional)	1	Input/Output board–1 (12 contacts relay output), Temperature/Humidity control output (SSR/SCR drive) (D.I: 8 contacts, DO: 12 contacts relay output external power supply) 24 V d.c., 18 W
	2	Input/Output board–2 (8 contacts open collector output external terminal board)
	3	Input/Output board–3 (8 contacts relay output board)
	4	Input/Output board–1 + (output board–2)
	5	Input/Output board–1 + (output board–3)
	N	No output board (when selected the main body)
Language	N	Korean/English (Standard type)
	2	English/Chinese (Simplified Chinese Characters)
	3	English/Chinese (Traditional Chinese Characters)

Temperature Controller

TH510 Programmable temperature & Humidity controller

Specification

Model	TH510		
Appearance			
W×H×D (mm)	145 × 145 × 33.5		
Power voltage	100 - 240 V a.c. Voltage regulation ±10 %		
Power frequency	50 - 60 Hz		
Power consumption	30 V A max		
Dielectric strength	Between 1st and 2nd terminals : Min. 1500 V a.c. for 1 min Between 1st and FG terminals : Min. 1500 V a.c. for 1 min Between 2nd and FG terminals : Min. 1500 V a.c. for 1 min		
Input type	2 types of thermoresistor (Pt-100, KPt-100) ±0.1 % of F,S ±1 Digit 2 types of DC voltage (1 - 5 V, 0 - 30 V) ±0.1 % of F,S ±1 Digit		
Sampling cycle	250 ms		
Contact output(DO)	Up to 32 relay	A Contact	30 V d.c. 3 A max, 250 V a.c. 3 A
		B Contact	NO : 30 V d.c. 5 A max, 250 V a.c. 5 A
Control output	SSR output	ON : 18 V d.c. Pulse voltage (800 Ω or more load resistance)	
	SCR output	4 - 20 mA d.c. (600 Ω or less load resistance)	
Transmission output	Current output	4 - 20 mA d.c.	
	Load resistance	600 Ω or less load resistance	
	Output type	Specific value(PV), Setting value(SV), Output(MV)	
	Refresh interval	250 ms	
Input	Input calibration (Sensor bias)	1 Temperature contact : EUS(0~100 %), 1 Humidity contact : EUS(0 ~ 100 %)	
	Dry/wet-bulb sensor compensation	Compensate the dry/wet sensor difference after removing the gauze of the wet-bulb sensor.	
	Scaling	DC voltage(VDC) : Input scaling according to conversion range	
	Input filter(LPF)	0 ~ 120 sec	
Control mode	Operation type	Constant-value / Program control	
Control output	Temperature control output	SSR output or SCR (4 - 20 mA d.c.) output	
	Humidity control output		
Control operation	Pattern	100 patterns(1 pattern/100 segments)	
	Segment	2,000 segments	
	PID Group	16 groups(temperature 4 zones X humidity 4 zones)	
	Auto tuning	Auto tuning according to target setting value	
	Proportional band	0.00 ~ 100.00 % (For 0.00 %, ON/OFF control)	
	Integral time	0.0 ~ 3,000 sec (OFF when 0 sec)	
	Derivative time		
ON/OFF control	Set 0.0 to proportional band(PB)		
Transmission output	Temperature, Humidity	4 - 20 mA d.c. Specific value(PV), Setting value(SV) and Output(MV)	
	Scaling	Auto scaling for defined upper/lower limit range (4 - 20 mA d.c.)	
Alarm setting	Alarm setting	System alarm : 8 points Assign 4 of 8 pattern alarms to a pattern	
	Alarm type	Absolute high/low limit, deviation high/low limit, in range/out of range (alarm direction, hold)	
	Absolute alarm setting range	EU (0 ~ 100 %)	
Display	TFT color LCD (115.2 × 86.4 mm)		
Number of Pixels	640 × 480 pixel		
Back light	LED back light		
Life cycle of back light	Approx. 40,000 h		
Touch type	Resistive type (4 Wires)		
Language	Korean/English/Chinese(Simplified)		
Internal memory	Non-volatile memory : 80 MB - Saving of 15 days at 1 S interval		
External memory	SD card(2 GB) : Saving of 1 year at 1 S interval		
Saving interval	1 - 360 S		
Memory information	Program information, setting value, recovery, and temperature setting / specific / output value		
Ambient temperature	0 ~ 50 °C		
Ambient humidity	20 ~ 90 % RH (Without condensation)		
Weight	Approx. 1.32 kg		

Temperature Controller

Suffix Code

Model	Code	Information
TH	<input type="checkbox"/> 1 0 - <input type="checkbox"/> <input type="checkbox"/> <input type="checkbox"/>	Programmable temperature controller
Display device	5	5.7" TFT-LCD
Input/output	1	8 input points/6 output points(1 module)
	2	8 input points/14 output points(2 modules)
	3	16 input points/16 output points(3 modules)
Language	S	Korean, English, and Chinese(Simplified)
	T	Korean, English, and Chinese(Traditional)
Communication	None	RS485
	E	RS485, Ethernet(OS)

※ Basic components (Power module, Control module)

※ This product consists of the display and control (Power, Control, Input, and Output Modules). (Up to 32 contact input/output points, respectively)

Components

Product	Model	Information
Display	TD510-DISPLAY	Display (5.7" TFT LCD)
Control module	TD510-MAIN	Temperature 2-channel control module
Power module	TM-PWR	Power module
Input module	TM-DI	Module with 16 input points
Output module	TM-DO	Module with 8 output points
Input/output module	TM-DIO	Module with 8 input and 6 output points

Temperature Controller
Recorder
Digital Counter
Timer
Analog Timer
Panel Meter
Multi Pulse Meter
Proximity Sensor
Photo Sensor
Rotary Encoder
Thyristor Power Regulator
Solid State Relay
Power Supply
Control Switch
Push Button / Main Switch
Cam Switch / Limit Switch
Micro / Hoist Switch
Foot / Mono Lever Switch
Signal Light
Terminal Block / Power Buzzer / Fuse Holder / Control Box

Temperature Controller

■ NP200 Programmable temperature controller

■ Specification

Model	NP200
Appearance	
W×H×D(mm)	96×96×100
Function	<ul style="list-style-type: none"> • Retransmission output • Input correction • Auto/Manual output • Heating/Cooling Control • Constant-value control • 5 Inner signals • Zone PID • 5 Time signals
Power voltage	100 – 240 V a.c. (50/60Hz)
Power consumption	Max. 10 VA (except communication)
Input	Multi input a) T.C : K, J, E, T, R, B, S, L, N, U, W, PLII, b) R.T.D : Pt100(KS/IEC), KPt100(KS) c) DC Voltage input : 1 to 5 V, 0 to 10 V, -10 to 20 mV, 0 to 100 mV, d) DC Current input : 4 to 20 mA(Connect a 250 Ω resistor to the input terminals)
Control output	Universal-output: Relay, SSR, Current
Control action	PID or ON/OFF
Alarm	4 Alarm output
Communication	RS 485/422 (Optional)
Setting	By Up/Down key on the front
Display	PV : Digital LED, SV : LCD Back light
Setting and display accuracy	0.1 % of F.S (Full Scale)
Setting resolution	1 or 0.1 % (According to input range)
Memory protection	Semipermanent
External control	4 Alarm output (Run, Reset, Step, Hold)
Number of pattern	30
Number of segment	300
Number of pattern contact	30
Operation	1 ~ 99 times or limitless
Program inclination	Hour, Minute
Sampling cycle	250 ms
Insulation resistance	500 V a.c. 20 MΩ min.
Dielectric strength	2300 V a.c. 50/60 Hz for 1 minute (Between primary and secondary terminal & between primary and ground)
Ambient temperature & humidity	0 ~ 50 °C, 35 ~ 85 % R.H.

■ Suffix Code

Model	Code	Information
NP200	<input type="checkbox"/> <input type="checkbox"/>	Programmable temperature controller, 96(W) X 96(H) mm
Control Types	0	Universal type (heating)
	1	Heating/cooling type (synchronous control type)
Option	0	None
	1	Communication function (RS485/422)
	2	Contact input(DI) 4 contacts
	3	Communication(RS485/422)+contact input 4 contacts

※ Option contact input 4 contacts are (DI-4) ~ (DI-7)

Temperature Controller

NP100 Programmable temperature controller

Specification

Model	NP100
Appearance	
W×H×D(mm)	96×96×100
Function	• Retransmission output • Input correction • Auto/Manual output • Heating/Cooling Control • 2 Alarm output (Relay) • 2 Time signals (Transistor)
Power voltage	100 – 240 V a.c. 50/60Hz
Power consumption	Max. 10 VA (except communication)
Input	Multi input 1) T.C : K, J, E, T, R, B, S, L, N, U, W, PLII, 2) R.T.D : Pt100(KS/IEC), KPt100(KS) 3) DC Voltage input : 1 to 5 V, 0 to 10 V, -10 to 20 mV, 0 to 100 mV, 4) DC Current input : 4 to 20 mA(Connect a 250 Ω resistor to the input terminals)
Control output	Universal-output : Relay, SSR, Current
Control action	PID or ON/OFF
Alarm	2 Alarm output
Communication	RS 485/422 (Optional)
Setting	By Up/Down key on the front
Display	PV/ SV : Digital LED
Setting and display accuracy	0.1 % of FS (Full Scale)
Setting resolution	1 or 0.1 % (According to input range)
Memory protection	Semipermanent
External control	3 Alarm output (Run, Reset, Hold)
Pattern and segment	2 Patterns, 20 Segments (10 Segments / 1 Pattern)
Operation	1 ~ 99 times or limitless
Program inclination	Hour, Minute
Sampling cycle	250 ms
Insulation resistance	500 V a.c. 20 MΩ min.
Dielectric strength	2,300 V a.c. 50/60 Hz for 1 minute (Between primary and secondary terminal & between primary and ground)
Ambient temperature & humidity	0 ~ 50 °C, 35 ~ 85 % R.H.

Suffix Code

Model	Code	Information
NP100	<input type="checkbox"/> <input type="checkbox"/>	Programmable temperature controller 96(W) X 96(H) mm
Control Types	0	Universal type (heating)
Option	0	None
	1	Time signal 2 contacts
	2	Communication function (RS485/422)
	3	Time signal 2 contacts and communication (RS485/422)

Temperature Controller

MC9 Multi channels digital temperature controller

Specification

Model	MC9
Appearance	
W×H×D(mm)	96 X 96 X 100
Function	<ul style="list-style-type: none"> Multi channels PID control device Various alarm functions (15 types) multi memory function (max 8 x 8 units) 3/4 channels control device DI contact input function Heating/cooling function (4 channels are possible only)
Power Voltage	110 – 220 V a.c. 50 – 60 Hz
Power consumption	100 V a.c. (below 14 VA) / 240V a.c. (below 20 VA)
Input	Input(Sensor type) selection by the configuration suffix code. a) T.C : K, J, E, T, R, B, S, L, N, U, W, PLII, b) R.T.D : Pt100 Ω(KS/IEC), KPt100 Ω(KS) c) DC Voltage input : 0 to 5 V, 1 to 5 V, 0 to 10 V, d) DC Current input : 4 to 20 mA(Connect a 250 Ω resistor to the input terminals)
Output	Type (Relay Output, Voltage Pulse Output, Triac Output, 4 – 20 mA Output, 0 – 20 mA Output)
Alarm	1a Contact Type / 250 V a.c., 1 A (for resistive load) / Life time: above 300,000 times ON/OFF
Communication	EIA RS485 / RS232C, Max. connecting units : 31 units (for RS485, Address can be set from 1 to 99) Communication method: 4–wire half duplex/ 2–wire half duplex, Communication Protocol: PC–LINK
Contact input	From Below 2 kΩ, ON, From Above 15 kΩ, OFF
Operating Environment	Temperature: 0 ~ 50 °C (32 ~ 122 °F), Humidity: 45 ~ 85 % RH (but, without condensation) Magnetic field : Below 400 AT/m Without poisonous gas and without full of dust

Suffix Code

MC9 (4 channels)

Model	Code	Information
MC9-4	<input type="checkbox"/> <input type="checkbox"/> <input type="checkbox"/> <input type="checkbox"/> <input type="checkbox"/> <input type="checkbox"/>	4 channels digital temperature controller dimension : 96(W) X 96(H) mm
Control type	D	Direct action (cooling action)
	R	Reverse action (heating action)
	W	Heating / Cooling (synchronous output)
Input type	<input type="checkbox"/>	Refer to the "Range and input code chart"
Heating output (output 1 ~ 4)	M	Relay
	S	SSR
	T	Triac
	4	4 – 20 mA d.c.
	5	0 – 20 mA d.c.
Cooling output (output 5~8) * in case of when control types are D and R then fix to N * in case of when control type is W then select among M,S,T, 4 and 5	N	NONE
	M	Relay
	S	SSR
	T	Triac
	4	4 – 20 mA d.c.
Optional	N	NONE
	1	AL2, AL3
	2	AL2, AL3 + RS232 + contact input
	3	AL2, AL3 + RS485 / 422 + contact input
Power Supply Voltage	2	100 – 240 V a.c. 50 / 60 Hz
	1	24 V d.c.

Temperature Controller

• MC9 (8 channels)

Model	Code					Information
MC9-8	<input type="checkbox"/>	<input type="checkbox"/>	<input type="checkbox"/>	<input type="checkbox"/>	<input type="checkbox"/>	8 channel digital temperature controller. Dimension : 96(W) X 96(H) X 100(D)
Control type	D					Direct action (cooling action)
	R					Reverse action (heating action)
Input type	<input type="checkbox"/>					Refer to the "Range and input code chart"
Heating output (output 1 ~ 4)	M					Relay
	S					SSR
	T					Triac
	4					4 - 20 mA d.c.
	5					0 - 20 mA d.c.
Cooling output (output 5~8) * in case of when control types are D and R then fix to N * in case of when control type is W then select among M,S,T, 4 and 5	N					NONE (when selected, input channels 5 ~ 8 are for indication)
	M					Relay
	S					SSR
	T					Triac
	4					4 - 20 mA d.c.
	5					0 - 20 mA d.c.
Optional	N					None
	2					RS232 + contact input
	3					RS485 / 422 + contact input
	4					Heater break
Power Supply Voltage	2					100 - 240 V a.c. 50/60 Hz
	1					24 V d.c.

Range and input code chart

Classification	Code	Input type	Range(°C)	Accuracy
Thermocouple	K0	K	-200 ~ 1370	Bigger one between the ±(0.3 % of FS ±1 Digit) or ±2 °C
	K1	K	-199.9 ~ 999.9	
	J0	J	-200 ~ 1200	
	J1	J	-199.9 ~ 999.9	
	E0	E	-199.9 ~ 999.9	
	E1	E	-199.9 ~ 999.9	
	T0	T	-199.9 ~ 400.0	
	R0	R	0 ~ 1700	
	R1	R	0.0 ~ 999.9	
	B0	B	0 ~ 1800	
	B1	B	0.0 ~ 999.9	
	S0	S	0 ~ 1700	
	S1	S	0.0 ~ 999.9	
	L0	L	-199.9 ~ 900.0	
	N0	N	-200 ~ 1300	
	N1	N	-199.9 ~ 999.9	
	U0	U	-199.9 ~ 400.0	
W0	W	0 ~ 2300		
A0	PL2	0 ~ 1390		
RTD	P0	KPt100 Ω	-199.9 ~ 500.0	Bigger one between the ±(0.3 % of FS ±1 Digit) or ±0.8 °C
	D0	Pt100 Ω	-199.9 ~ 600.0	
DC voltage	V0	0 - 5 V	-199.9 ~ 999.9	± (0.3 % of FS ± 1 Digit)
	V1	1 - 5 V	-199.9 ~ 999.9	
	V2	0 - 10 V	-199.9 ~ 999.9	

Temperature Controller

■ ML Multi channels temperature controller (Module type)

■ Specification

Model		ML-D2H	ML-D4	ML-E
Appearance				
W×H×D(mm)		30 X 100 X 96.9		
Power source voltage		24 V d.c.		
Voltage regulation		±10 % of power source voltage		
Power consumption		ML-D4S/C Maximum 7W below	ML-D4M Maximum 5W below	ML-D2HMS/SS Maximum 7W below
		ML-D2H Maximum 5W below	ML-E Maximum 3W below	
Thermo couple		K, J, E, T, R, B, S, L, N, U, W, PL2		
Thermo-resistor		Pt100 Ω, KPt100 Ω		
Direct current voltage		0 - 100 mV, 1 - 5 V, 0 - 10 V		
Sampling cycle		50 ms.		
Input indication resolution		Below minimum unit of input range		
Input impedance		Thermo couple and direct current voltage input: over 1 MΩ		
Impact of allowed input resistance		About 0.2 μV / Ω		
Allowed input conducting wire resistance		Thermo-resistor (below 10 Ω, however, resistance among 3 lines should be same)		
Allowed input voltage		Within -2 - 5 (Thermo couple, thermo-resistor), within -5 - 12 V (direct current, voltage)		
Input compensation		±100% of input range		
Cold junction compensation error		±1.5 °C (0 ~ 50 °C)		
Input signal break detection		up scale		
Control output		RELAY		-
		1a contract point		
		250 V a.c. 3 A, 30 V d.c. 3 A		
		Over 12 V (over 600 Ω of load resistance) if short circuit, limit to about 25 mA		
SSR		Time resolving power : larger side between control cycle 0.1% or 10 ms		
		Resolution 4 -20 mA d.c. (below load resistance 600 Ω)		
		Degree : ±0.1% of FS (4-20 mA scope)		
RS485 communication		Communication method		RS-485 EIA standard / 2 line type half duplex
		Maximum number of access		31 units
		Maximum communication distance		1200 m
		Communication sequence		No sequence
		Communication speed		9600, 19200, 38400, 76800, 87600 bps [initial value: 9600]
		Start bit		1 bit
		Data length		7, 8 bit [initial value: 8]
		Parity bit		None, Odd, Even [initial value: Even]
		Stop bit		1, 2 bit [initial value: 1]
		Response time		Reception handling time + (response time x 10 ms)
Support protocol		PC-Link, PC-Link with SUM, Modbus ASCII/RTU [initial value: PC-Link]		
Usage surroundings temperature		0 ~ 50 °C		
Usage surroundings humidity		35 ~ 85% RH (however, there should not be condensation)		
Run environment		Should not be used in areas with toxic gas, magnetic field or dust		
Warming up time		Minimum 30 minutes		
Influence by surrounding temperature		Thermo couple, direct current voltage: Larger side between ±3 μV / °C or ±0.03% of FS / °C Thermo-resistor: Below ±0.1 °C / °C		
Influence by power supply change		Larger side between ±3 μV / 10 V or ±0.03 % of FS / 10 V		
Storage temperature		-25 ~ 65 °C		
Storage humidity		5 ~ 95% RH (however, there should not be condensation)		
Shock		Less than 1 m in packaged condition		
Weight		About 220g (excluding box)		

Temperature Controller

Suffix Code

■ Module type temperature controller (ML-D2H)

Model	Code	Information
ML-D	2 H <input type="checkbox"/>	Module type temperature controller
Number of channels	2	2 channel
Input	H	Heating/cooling control (simultaneous), heater break alarm (HBA)
Control output	MM	OUT1 (heating)
		OUT2 (cooling)
	SM	OUT1 (heating)
		OUT2 (cooling)
	SS	OUT1 (heating)
		OUT2 (cooling)

■ Module type temperature controller (ML-D4)

Model	Code	Information
ML-D	4 <input type="checkbox"/>	Module type temperature controller
Number of channels	4	4 channel
Control output	M	Relay output
	S	SSR output (12 V d.c.)
	C	SCR output (4 – 20 mA d.c.)

Ex: Temperature control system 4 channel relay output : ML-D4M

■ Module type event output (ML-E)

Model	Information
ML-E	Module type 8 events output unit

Temperature Controller

Recorder

Digital Counter
Timer

Analog Timer

Panel Meter

Multi Pulse Meter

Proximity Sensor

Photo Sensor

Rotary Encoder

Thyristor Power Regulator

Solid State Relay

Power Supply

Control Switch

Push Button / Main Switch

Cam Switch / Limit Switch

Micro / Hoist Switch

Foot / Mono Lever Switch

Signal Light

Terminal Block / Power Buzzer / Fuse Holder / Control Box

Temperature Controller

SM100 Multi channel temperature controller (Board type)

Specification

Model		SM100-□□12	SM100-□□16	SM100-□□20
Appearance				
Number of channels		12 Channel	16 Channel	20 Channel
Measurement Input	Input type	Thermocouple (K type), RTD (Pt100 Ω IEC 751)		
	Display accuracy	±0.5 % of FS (* ±0.5 % of max range)		
	RJC compensation accuracy	±3.5 °C		
	Sampling Input	1 sec		
	Input filter	0 ~ 120.0 sec		
	Burn-out action	Thermocouple: Up Scale when break, RTD: Up Scale when break		
compensation		±1200.0 °C		
Control Output	Output type	SSR driving voltage pulse output (min 12 V d.c.), Load resistance (min 600 Ω)		
	Control action	Time proportional PID or ON / OFF control		
	Proportional cycle	1 ~ 100 sec		
	Proportional band	0 ~ 1200.0 °C		
	Integral time	1 ~ 3600 sec		
	Derivative time	1 ~ 3600 sec		
	Over integral limitation (ARW)	0.1 ~ 100.0 %, * "0" setting (Auto)		
	Hysteresis	0 ~ 120.0 °C (* ON/OFF width when selecting ON/OFF control)		
	Manual reset	0.0 ~ 100.0 % (* when selecting ON/OFF control)		
	Output amount in emergency situation	0.0 ~ 100.0 % (output amount)		
Output limit		0 ~ 100 %		
Output action change		Direct/Reverse action (selectable by internal parameter)		
Power supply voltage		100 - 240 V a.c. 50 - 60 HZ, 24 V d.c.		
Power supply voltage fluctuation		± 10 % of the rated power supply voltage		
Power consumption		25 V A max.		
Insulation resistance		20 MΩ min. power terminal and earth (ground) terminal (500 V d.c. mega)		
Dielectric strength		2,000 V a.c. for 1min. power terminal and earth (ground) terminal		
Ambient temperature		0 °C ~ 50 °C		
Ambient humidity		20 % ~ 85 RH (dew condensation not allowed)		
Storage temperature		-20 °C ~ 70 °C (dew condensation not allowed)		
Vibration resistance		10 - 55 Hz 19.6 % 3 axis 6 directions 2 h		
Shock resistance		196 % 3 axes 3 times to each of 6 directions		
Case material		SPC		
Installation		Fixed with screws		
Weight		approx. 1,000 g		



Suffix Code

Model	Code	Information
SM100-	□ □ □	Multi channel temperature controller (Board type)
Input type	K	K type thermocouple input
	P	Pt100 Ω RTD input
Output form	N	No control output (exclusive for measured value)
	A	Control output
Number of control contact	12	12 channel
	16	16 channel
	20	20 channel
Power	A	100 - 240 V a.c. 50 - 60 Hz
	D	24 V d.c.

Temperature Controller

■ PX series Digital temperature controller

■ Specification

Model	PX9	PX7
Appearance		
W×H×D(mm)	96×96×100	72×72×100
Function	<ul style="list-style-type: none"> • Fuzzy • Zone PID • Group PID • Auto tuning • 3 Alarm outputs • Universal—input/output • External contact input • Ramp & Soak • Output limitation • Heating/Cooling control • Interface (RS485 / 422) • Protection : IP 65 (Front) • Input filter : OFF, 1 ~ 120 sec. • Retransmission output (PV, SV, MV) • Heating/Cooling hysteresis 	
Input	Multi input a) TC : K, J, E, T, R, B, S, L, N, U, W, PLII, b) RTD : Pt100(KS)/IEC, KPt100(KS) c) DC Voltage input : 1 to 5 V, -10 to 20 mV, 0 to 100 mV, d) DC Current input : 4 to 20 mA(Connect a 250 Ω resistor to the input terminals)	
Sampling cycle	250 ms (Remote input : 500 ms)	
Input display resolution	Below decimal point of Input signal and measuring range	
Input impedance	Min 1 MΩ (Thermocouple, DC voltage input)	
Source tolerable resistance	Thermocouple : 250 Ω max, DC voltage : 2 kΩ max	
Lead wire tolerable resistance	RTD : Max. 10 Ω/wire (notice : Identical conductor resistance between 3 wires)	
Input tolerable voltage	±10 V (TC, RTD, DC voltage : mV d.c.), ±20 V (Voltage : V d.c.)	
Scaling	According to setting max. value(SH), min. value(SL) of measuring range, scaling is available (-1999 ~ 9999)	
Cold junction temp. compensation tolerance	±1.5 °C(15 ~ 35 °C), ±2.0 °C(0 ~ 50 °C)	
Accuracy	±0.1 % (Full scale)	

■ Suffix Code

Model	Code	Information
PX-	<input type="checkbox"/> <input type="checkbox"/> <input type="checkbox"/>	Multi input/output temperature controller
Dimension	7	72(W) X 72(H) mm
	9	96(W) X 96(H) mm
Control type	0	Standard
	1	Heating/cooling control (synchronous control output)
Option	0	NONE
	1	PX7 : RS485/422, OUT2, REM(Remote input function) PX9 : RS485/422, HBA 2 Contact, REM
	2	RS485/422, OUT2, HBA 1 Contact
	3	Contact input (D,I), OUT2, HBA 1 Contact

Note) 1) Only option 1 is available with PX9,





2) All options are available with PX7

Temperature Controller
Recorder
Digital Counter
Timer
Analog Timer
Panel Meter
Multi Pulse Meter
Proximity Sensor
Photo Sensor
Rotary Encoder
Thyristor Power Regulator
Solid State Relay
Power Supply
Control Switch
Push Button / Main Switch
Cam Switch / Limit Switch
Micro / Hoist Switch
Foot / Mono Lever Switch
Signal Light
Terminal Block / Power Buzzer / Fuse Holder / Control Box

Temperature Controller

AX series Multi input digital temperature controller

Specification

Model		AX9	AX2	AX7	AX3	AX4
Appearance						
W×H×D (mm)		96 X 96 X 63	48 X 96 X 63	72 X 72 X 63	96 X 48 X 63	48 X 48 X 63
Input type		Multi input (Thermocouple: K, J, R, T, IEC 584-1), (RTD: Pt 100 Ω, IEC751)				
Sampling cycle		100 ms				
Input impedance		max 1 MΩ				
Allowable input voltage		10 V d.c. max				
Display accuracy		±0.3 % of FS ±1 digit (In case of R type, ±1.0 % of ±1 digit in the 0 ~ 600 °C range)				
Display type		7 Segment LED (PV: red, SV: green)				
Front Size (mm)	PV	22.5×11.2	14.5×7.0	14.5×7.0	15.9×7.6	13.0×6.5
	SV	18.7×9.3	10.8×5.2	9.4×4.7	12.0×6.0	9.2×5.2
Input		<ul style="list-style-type: none"> Thermocouple : 0.1 °C (TC-K2, TC-J), 0.5 °C (TC-K1) RTD : 0.03 °C, (0.1 °F) 				
Insulation resistance		min 20 MΩ, 500 V d.c. 1 minute (primary terminal-secondary terminal)				
Dielectric strength		2300 V a.c. 50/60 Hz, for 1min (primary terminal-secondary terminal)				
Control method		PID control by Auto-Tuning, ON / OFF control.				
Control output operation		Reverse operation / Direct operation selectable by the parameter setting				
Control output		<ul style="list-style-type: none"> Relay output ※Selectable by the parameter setting 1a contact, 3A 240 V a.c., 3 A 30 V d.c. (resistive load) Voltage pulse output for running SSR [time sharing proportional control (CYC)] Voltage pulse output for running SSR 0/12 V d.c., pulse voltage (resistive load minimum 600 Ω) 				
Power supply voltage		100 – 240 V a.c. 50 / 60 Hz				
Voltage fluctuation		± 10 % of the power supply voltage				
Power consumption		Within 5.5 VA				
Ambient temperature		– 5 ~ 50 °C				
Ambient humidity		35 ~ 85 % R.H.(but without dew condensation)				
Vibration resistance		10 – 55 Hz, 0.75 mm, each to direction X, Y and Z for 2 hours				
Shock resistance		300 m/s ² to direction 6 each 3 times				
Weight (Weight included the weight of box)		320 g	320 g	180 g	300 g	400 g

Suffix Code

Model	Code	Information
AX	<input type="checkbox"/> <input type="checkbox"/> <input type="checkbox"/>	Digital temperature controller (Multi input: K, J, Pt100 Ω)
Dimension	2	AX2 : 48 X 96 mm
	3	AX3 : 96 X 48 mm
	4	AX4 : 48 X 48 mm
	7	AX7 : 72 X 72 mm
	9	AX9 : 96 X 96 mm
Output selection	1	SSR + Relay1 + Relay2
	2	SSR + Relay1 + Relay2 + Relay3
	1B	SSR + Relay1(Form c) + Relay2
	2B	SSR + Relay1(Form c) + Relay2 + Relay3
	3	4 – 20 mA + Relay2
4	4 – 20 mA + Relay2 + Relay3	
Power supply voltage	A	100 – 240 V a.c. 50 / 60 Hz





※ Form C : Normal close type contact.

※ Relay output operates as control output, alarm output and LBA output depending on the internal parameter setting.

Temperature Controller

■ NX series Multi input/output digital temperature controller (PID Auto-tuning)

■ Specification

Model	NX9	NX2	NX7	NX3
Appearance				
W×H×D(mm)	96×96×100	48×96×100	72×72×100	96×48×100
Function	<ul style="list-style-type: none"> • Fuzzy • Zone PID • Group PID • Auto tuning • 2 Alarm outputs • Universal-input/output • External contact input • Output limitation • Heating/Cooling control • Heater Break Alarm (HBA1) • Interface (RS485 / 422) • Protection:IP 65 (Front) • Input filter : OFF, 1~120 sec. • Retransmission output (PV, SV, MV) • Heating/Cooling hysteresis 			
Input	Multi input a) T.C : K, J, E, T, R, B, S, L, N, U, W, PL11, b) R.T.D : Pt100(KS/IEC), KPt100(KS) c) DC Voltage input : 1 to 5 V, -10 to 20 mV, 0 to 100 mV, d) DC Current input : 4 to 20 mA(Connect a 250 Ωresistor to the input terminals)			
Sampling cycle	250 ms			
Input display resolution	Below decimal point of Input signal and Measuring range			
Input impedance	TC and DC mV input : Min 1 MΩ, DCV : Approx. 1 MΩ			
Source tolerable resistance	Thermocouple : Max. 250 Ω, Voltage : Max. 2 kΩ			
Lead wire tolerable resistance	RTD : Max. 10 Ω /wire (notice : Identical conductor resistance between 3 wires)			
Input tolerable voltage	±10 V (TC, RTD, Voltage : mV d.c.), ±20 V (Voltage: V d.c.)			
Cold junction temp. compensation tolerance	±1.5 °C (15 ~ 35 °C), ±2.0 °C (0 ~ 50 °C)			
Accuracy	±0.5 % (Full scale)			

■ Suffix Code

Model	Code	Information
NX	<input type="checkbox"/> <input type="checkbox"/> <input type="checkbox"/>	Multi input/output temperature controller
Dimension	2	48(W) X 96(H) mm
	3	96(W) X 48(H) mm
	7	72(W) X 72(H) mm
	9	96(W) X 96(H) mm
Control type	0	Standard
	1	Heating/Cooling control (synchronously)
NX9 Option	0	NONE
	1	RS485, HBA
NX7 Option	0	NONE
	1	RS485, HBA
	2	SV2, SV3, HBA
NX2, 3 Option	0	SV2, SV3
	1	HBA
	2	RS485

Temperature Controller

■ NX4 Multi input/output digital temperature controller (PID Auto-tuning)

Specification

Model	NX4
Appearance	
W×H×D(mm)	48 X 48 X 100
Function	<ul style="list-style-type: none"> • Zone PID • Group PID • Auto tuning • 2 Alarm outputs • Universal-input/output • External contact input • Output limitation • Heating/Cooling control • Heater Break Alarm (HBA1) • Interface (RS485 / 422) • Protection:IP 65 (Front) • Input filter : OFF, 1~120 sec. • Retransmission output (PV, SV, MV) • Heating/Cooling hysteresis
Input	<p>Multi input</p> <p>a) T.C : K, J, E, T, R, B, S, L, N, U, W, PLIL, b) R.T.D : Pt100(KS/IEC), KPt100(KS)</p> <p>c) DC Voltage input : 1 to 5 V, -10 to 20 mV, 0 to 100 mV,</p> <p>d) DC Current input : 4 to 20 mA(Connect a 250 Ω resistor to the input terminals)</p>
Sampling cycle	250 ms
Input display resolution	Below decimal point of Input signal and Measuring range
Input impedance	TC and DC mV : Min 1 MΩ, DCV : Approx. 1 MΩ
Source tolerable resistance	Thermocouple : Max. 250 Ω, Voltage : Max. 2 kΩ
Lead wire tolerable resistance	RTD : Max. 10 Ω / wire (notice : Identical conductor resistance between 3 wires)
Input tolerable voltage	±10 V (TC, RTD, Voltage : mV d.c.), ±20 V (Voltage : V d.c.)
Cold junction temp. compensation tolerance	±1.5 °C (15 ~ 35 °C), ±2.0 °C (0 ~ 50 °C)
Accuracy	±0.5 % (Full scale)

Suffix Code

Model	Code	Information
NX4-	<input type="checkbox"/> <input type="checkbox"/>	Multi input/output temperature controller, 48(W) X 48(H)
Control type	0	Standard
	1	Heating/cooling control (synchronous control)
	2	Heating/cooling control (only for NX4-20)
NX4 Option	0	NONE
	1	HBA, AL2
	2	SV2, SV3
	3	RET, RS485
	4	RS485, SSR / SCR
	5	AL1, AL2
	6	AL1, AL2, SV2
7	RS485, HBA	

Note) Option 1: OUT1 (terminal 1-2-3) is applied as AL1 But, only with control output SSR/SCR selection

Option 3: OUT2 (terminal 11-12) is applied as RET

Option 4: OUT2 (terminal 11-12) is applied as SSR / SCR

Option 5: OUT1 (terminal 6-7) is impossible to apply as SV2

Option 6: OUT1 (terminal 6-7) is applied as SV2 but only with relay control output.

Temperature Controller

■ NX1 Multi input/output digital temperature controller (PID Auto-tuning)

■ Specification

Model	NX1		
Appearance			
W×H×D(mm)	48 X 24 X 100		
Function	<ul style="list-style-type: none"> • Zone PID • Group PID • Auto tuning • 2 Alarm outputs • Universal-input/output • External contact input • Output limitation • Heating/Cooling control • Heater Break Alarm (HBA1) • Interface (RS485 / 422) • Protection:IP 65 (Front) • Input filter : OFF, 1~120 sec. • Retransmission output (PV, SV, MV) • Heating/Cooling hysteresis 		
Input	Multi input a) T.C : K, J, E, T, R, B, S, L, N, U, W, PLI, b) R.T.D : Pt100(KS)/IEC, KP100(KS) c) DC Voltage input : 1 to 5 V, -10 to 20 mV, 0 to 100 mV, d) DC Current input : 4 to 20 mA(Connect a 250 Ω resistor to the input terminals)		
Sampling cycle	250 ms		
Input display resolution	Below decimal point of Input signal and Measuring range		
Input impedance	TC and DC mV : Min 1 MΩ, DCV : Approx. 1 MΩ		
Source tolerable resistance	Thermocouple: Max. 250 Ω, Voltage: Max. 2 kΩ		
Lead wire tolerable resistance	RTD: Max. 10 Ω /wire (notice: Identical conductor resistance between 3 wires)		
Input tolerable voltage	±10 V (TC, RTD, Voltage : mV d.c.), ±20 V (Voltage : V d.c.)		
Standard junction temp. compensation tolerance	±1.5 °C (15 ~ 35 °C), ±2.0 °C (0 ~ 50 °C)		
Accuracy	±0.5 % (Full scale)		





■ Suffix Code

Model	Code	Information		
NX1-	<input type="checkbox"/> <input type="checkbox"/>	Multi input/output temperature controller, 48(W) X 24(H) mm		
Control type	0	Universal type		
	1	Heating/Cooling control (synchronously)		
Regular type option		Type options	Heating output	Cooling output
	0	RET	Relay	-
	1	None	SSR/SCR	-
	2	RS485/RET	Relay	-
	3	RS485	SSR/SCR	-
	4	ALM	SSR/SCR	-
Heating / cooling type option	5	ALM/RS485	SSR/SCR	-
	0	None	Relay	SSR/SCR
	1	None	SSR/SCR	Relay
	2	RS485	Relay	SSR/SCR

Temperature Controller

HX series Multi input/output Digital temperature controller

Specification

Model	HX9	HX2	HX7	HX3	HX4
Appearance					
W×H×D (mm)	96 X 96 X 63	48 X 96 X 63	72 X 72 X 63	96 X 48 X 63	48 X 48 X 63
Power supply Voltage	100 – 240 V a.c. (±10 %), 50/60 Hz				
Power consumption	6 W max, 10 VA max				
Input	Type	Refer to "input code for input type and range"			
	Sampling cycle	62,5 ms			
	Accuracy	±0.5 % of FS (refer to "input code for input type and range")			
	Allowable voltage	Within ±20 V d.c. (VDC), within ±10 V d.c. (TC, RTD)			
	Reference junction compensation accuracy	±3.5 °C (0 ~ 50 °C)			
Operation after input break	TC: OFF, UP/DOWN RTD: UP				
Control output	Relay	NO : 5 A 250 V a.c., 5 A 30 V d.c. (resistive load), NC : 3 A 250 V a.c., 1 A 30 V d.c. (resistive load)			
	SSR (voltage pulse)	ON voltage : 12 V d.c. min, OFF voltage : 0.1 V d.c. max, Load resistance 600 Ω min			
	SCR (current)	range : 4 – 20 mA (±5%), accuracy : ±0.2 mA, Load resistance 600 Ω max ■ range : 4 – 20 mA (±5%), accuracy : ±0.2 mA Load resistance 600 Ω max ■ range : 0 – 20 mA (±5%), accuracy : ±0.2 mA Load resistance 600 Ω max			
Retransmission output					
Alarm output	5 A 250 V a.c., 5 A 30 V d.c. (Resistive load)				
Contact input	OFF resistance : 10 kΩ min, ON resistance : 1 kΩ max				
Control	Method	ON/OFF, PID control			
	Output operation	Reverse operation, Direct operation			
	Anti-reset windup	Auto(A=0), 0.1 ~ 100.0 %			
Interface	Standard	EIA RS485			
	Max connection unit	31 units (but, ADDRESS setting : 1 ~ 99)			
	Communication method	2 wire half duplex			
	Data transmission	asynchronous			
	Communication sequence	None			
	Communication distance	Within 1.2 km			
	Communication Speed	2400, 4800, 9600, 14400, 19600 BPS (selectable by parameter)			
	Start bit	1 BIT			
	Data length	7 or 8 BIT			
	Parity bit	NONE, EVEN, ODD			
Stop bit	1 or 2 BIT				
Protocol	PC.LINK, PC.LINK SUM, MODBUS-ASCII, MODBUS-RTU				
Response time	Processing time in receiving + (response time x 25 ms)				
Insulation resistance	20 MΩ min (primary terminal - secondary terminal)				
Dielectric strength	2,300 V a.c., for 1 minute (primary terminal - secondary terminal)				
Operating ambient temperature	0 ~ 50 °C, (without condensation)				
Operating ambient humidity	35 ~ 85 % RH (without condensation)				

Suffix Code

Model	Code	Information
HX	<input type="checkbox"/> <input type="checkbox"/> <input type="checkbox"/>	Multi-input and output digital temperature controller
Dimension	2	48(W) × 96(H) mm
	3	96(W) × 48(H) mm
	4	48(W) × 48(H) mm
	7	72(W) × 72(H) mm
	9	96(W) × 96(H) mm
Control output	0	Standard
	1	Heating/cooling control (simultaneous control)
HX2/3/9 option	0	None
	1	RS485 communication + Heater break alarm (HBA)
HX7 option	0	None
	1	RS485 communication + D.I 2 contacts (SV2, SV3)
	2	RS485 communication + Heater break alarm (HBA)
HX4 option	0	None
	1	RS485 communication + D.I 1 contact (SV2)
	2	RS485 communication + Heater break alarm (HBA)

Temperature Controller

Range and input code chart

Input signal	Input signal	Input type	Range (°C)	Accuracy	Note	
Thermocouple (TC)	1	K	*1	-200 ~ 1370	±0.5 % of FS ±1 Digit	• FS is the measurable range from the maximum to the minimum for each range. • Digit is the minimum display value *1 below 0 °C : ±1.0 % of FS ± 1 digit *2 0 ~ 400°C range : ±10 % of FS ± 1 digit *3 20 → KPt100 Ω (C1603) 21, 22 → Pt100 Ω(IEC751) *4 In case of using Current input, Resistor 250 Ω 0.1 % should be installed in the input terminal.
	2	K	*1	-199.9 ~ 999.9		
	3	J	*1	-100.0 ~ 999.9		
	4	E	*1	-100.0 ~ 999.9		
	5	T	*1	-199.9 ~ 400.0		
	6	R		0 ~ 1700		
	7	B	*2	0 ~ 1800		
	8	S		0 ~ 1700		
	9	L	*1	-100.0 ~ 900.0		
	10	N		-200 ~ 1300		
	11	U	*1	-199.9 ~ 400.0	±0.5 % of FS ±1 Digit	
	12	W		0 ~ 2300		
	Resistance temperature detector (RTD)	20	KPt100 Ω	*3	-199.9 ~ 500.0	
21		Pt100 Ω	*3	-199.9 ~ 640.0		
22		Pt100 Ω	*3	-200 ~ 640		
DC voltage (VDC / mV DC)	30	1,000 – 5,000 V DC		-1999 ~ 9999	±0.5 % of FS ±1 Digit	
	31	0.0 – 100.0 mV DC		Scaling function(SL-H/SL-L) necessary		
DC current	30	4 – 20 mA DC	*4			

UX100 Multi input/output digital temperature controller

Specification

Model	UX100
Appearance	
W×H×D (mm)	48 X 24 X 100
Function	• Fuzzy • Input correction • Interface (RS485) • Heating/Cooling control • Output limitation • Auto tuning • ARW • Input filter: OFF, 1 ~ 120 sec. • Universal-input • Heating/Cooling hysteresis • Alarm output
Input	Multi input a) T.C : K, J, E, T, R, B, S, L, N, U, W, PLI, b) R.T.D : Pt100(KS/IEC), KP100(KS) c) DC Voltage input : 1 to 5 V, -10 to 20 mV, 0 to 100 mV, d) DC Current input : 4 to 20 mA(Connect a 250 Ω resistor to the input terminals)
Sampling cycle	250 ms
Input display resolution	Below decimal point of Input signal and Measuring range
Input impedance	TC and DC mV : Min 1 MΩ, DCV : Approx. 1 MΩ
Source tolerable resistance	Thermocouple: Max, 250 Ω, Voltage: Max. 2 kΩ
Lead wire tolerable resistance	RTD: Max. 10 Ω/wire
Input tolerable voltage	±10 V (TC, RTD, Voltage: mV d.c.), ±20 V (Voltage: V d.c.)
Scaling	According to setting Max. value(SH), Min. value(SL) of measuring range, scaling is available (-1999 ~ 9999)
Cold junction temp. compensation tolerance	±1.5 °C (15 ~ 35 °C), ±2.0 °C (0 ~ 50 °C)
Accuracy	±0.5 % (Full scale)





Suffix Code

Model	Code	Information
UX100-	<input type="checkbox"/> <input type="checkbox"/>	Multi input/output temperature controller, 48(W) X 24(H) mm
Control type	0	Standard
	1	Heating/cooling control (but heating side cannot use relay)
Option	0	None
	1	Communication function (RS 485)

Temperature Controller

KX series Multi input Digital temperature controller (PID Auto-tuning)

Specification

Model	KX9N	KX2N	KX7N	KX3N	KX4N
Appearance					
W×H×D(mm)	96 X 96 X 100	48 X 96 X 100	72 X 72 X 100	96 X 48 X 100	48 X 48 X 100
Function	<ul style="list-style-type: none"> • Built-in PID auto tuning function • Direct/Reverse operation selection function • Alarm (ALH, ALL, LBA) • Upper/Lower limit setting limitation function • Setting data lock function • Input compensation function • Decimal point display function 				
Power Voltage	100 – 240 V a.c. 50 – 60 Hz (voltage fluctuation rate: ±10 %)				
Power Consumption	approx. 11 VA max				
Input	Multi input a) TC : K, J, E, T, R, B, S, L, N, U, W, Pt100, b) RTD : Pt100(KS/IEC), KP100(KS) c) DC Voltage input : 1 to 5 V, 0 to 10 V, d) DC Current input : 4 to 20 mA (Connect a 250 Ω resistor to the input terminals)				
Control Output	<ul style="list-style-type: none"> • Relay: 250 V a.c. 3 A (Resistive load) • SSR : 12 V d.c. pulse voltage(Load resistance ±0.2 mA 600 Ω min) • Current Output: 4 – 20 mA d.c. (Load resistance 600 Ω max) 				
Control type	<ul style="list-style-type: none"> • PID operation • ON/OFF operation 				
Alarm Output	ALH, ALL (250 V a.c. 3 A)				
Loop Break Alarm	LBA (250 V a.c. 3 A)				
Setting Method	Digital Setting by Up/Down Keys				
Accuracy	±0.5 % of FS (Please refer to Input code)				
Dielectric Strength	2,300 V a.c. 50/60 Hz, for 1 minute (Primary terminal–secondary terminal)				
Operating Ambient Temperature/Humidity	0 ~ 50 °C / 35 ~ 85 % RH (without condensation)				

Suffix Code





Model	Code	Information	
KX	<input type="checkbox"/> - <input type="checkbox"/> <input type="checkbox"/> <input type="checkbox"/> <input type="checkbox"/> <input type="checkbox"/>	Digital Temperature Controller	
Dimension	2N	48(W) X 96(H) mm	
	3N	96(W) X 48(H) mm	
	4N	48(W) X 48(H) mm	
	7N	72(W) X 72(H) mm	
	9N	96(W) X 96(H) mm	
	4S	48(W) X 48(H) mm	for 11 pin socket
Control output	M	Relay	
	S	SSR (voltage pulse 12 V d.c.)	
	C	SCR (Current 4 – 20 mA d.c.)	
Alarm output	C	※ KX4N, KX4S selection only	ALH, ALL, LBA (1a common output)
		※ Unavailable KX4S	
	E	KX2N, KX3N, KX9N	ALH(1c),ALL(1a)
		KX7N, KX4N (optional)	ALH(1a),ALL(1a)
	K	※ Unavailable KX4N, KX4S	
		KX2N, KX3N, KX9N (optional) KX7N (optional)	ALH(1c),ALL(1a),LBA(1a) ALH(1a),ALL(1a),LBA(1a)
Retransmission output (Optional)	A	※ Only selectable with models given in the below KX4N-□C KX2N-□E, KX3N-□E, KX9N-□E KX2N-□K, KX3N-□K, KX9N-□K	Retransmission output(RET) 4 – 20 mA d.c.
	N	None	
Power Supply Voltage	A	100 – 240 V a.c. 50 – 60 Hz	
	D	24 V d.c. (Unavailable in KX4S)	

※ When using 4 – 20 mA input, attach 0.1 % of 250 Ω resistance to the input terminal of 1 – 5 V d.c.

Temperature Controller

DX series Simple operation, approved function (PID Auto-tuning)

Specification

Model		DX9	DX2	DX7	DX3	DX4
Appearance						
W×H×D (mm)		96 X 96 X 100	48 X 96 X 100	72 X 72 X 100	96 X 48 X 100	48 X 48 X 100
Power supply		100 – 240 V a.c. (± 10 %), 50 – 60 Hz				
Power consumption		Max. 12 VA				
Input	Type	Input(Sensor type) selection by the configuration suffix code. a) Thermo couple : K, J,R, b) R.T.D : KP100 Ω(KS), Pt100 Ω(IEC751), c) DC current input : 4 to 20 mA, d) DC voltage : 1 to 5 V, 0 to 10 V				
	Sampling Cycle	250 ms				
	Accuracy	± 0.5 % of FS (DCV Input : ±1 % of FS)				
	Tolerable voltage	20 V d.c. for 1 minute				
	Cold junction compensation error	± 3.5 °C (Within 0 ~ 50°C)				
Output	Relay output	NO : 5 A 250 V a.c., 5 A 30 V d.c. (Resistive load), NC : 3 A 250 V a.c., 1 A 30 V d.c. (Resistive load), Switching Life : 1,000,000 times (No-load)				
	Voltage output	ON voltage : 12 V d.c. Min, OFF voltage : 0.1 V d.c. max, Resistive load 600 Ωmin.				
	Current output	4 – 20 mA d.c. (Load resistance 600 Ω max.) Accuracy : ±0.2 mA				
Transmission output		4 – 20 mA d.c. (Load resistance 600 Ω max.) Accuracy : ±0.2 mA				
Alarm		5 A 250 V a.c., 5 A 30 V d.c. (Resistive load), Switching Life : 1,000,000 times (No-load)				
Control	Type	ON/OFF, PID control				
	Operation	Reverse, Direct				
	ARW	Auto(A=0), 0.1 ~ 100.0 %				
Insulation resistance		More than 20 MΩ between Primary terminal and secondary terminal				
Dielectric strength		2,300 V a.c., for 1 minute between Primary terminal and secondary terminal				
Operating environment	Temp. & Humidity	0 ~ 50 °C, 35 ~ 85 % RH (No condensation)				
	Environment	Refer to "safety information"				

Suffix Code

Model	Code	Information
DX	<input type="checkbox"/> - <input type="checkbox"/> <input type="checkbox"/> <input type="checkbox"/> <input type="checkbox"/> <input type="checkbox"/> <input type="checkbox"/> <input type="checkbox"/>	Digital temperature controller
Dimension	2	48(W) x 96(H) mm
	3	96(W) x 48(H) mm
	4	48(W) x 48(H) mm
	7	72(W) x 72(H) mm
	9	96(W) x 96(H) mm
Input	K	K thermocouple
	J	J thermocouple
	R	R thermocouple
	D	RTD (KPt 100 Ω)
	P	RTD (Pt 100 Ω)
	V	1 – 5 V d.c.
	C	4 – 20 mA d.c.
F	0 – 10 V d.c.	
Control output	M	Relay contact output
	C	Current output (4 – 20 mA d.c.)
	S	SSR (voltage pulse output, 12 V d.c.)
Alarm output	S	Alarm output 1 contact (model : DX4)
	W	Alarm output 2 contact (all models except DX4)
Optional	A	Retransmission output (4 – 20 mA d.c. measured value)
	N	None (DX4, DX7 No retransmission output)
Control operation ※selection by SL9 (initial value : R)	R	Reverse action (heating control)
	D	Direct action (cooling control)
Power Supply Voltage	•	No indication (100 – 240 V a.c.)
	C	24 V d.c. / a.c.

Temperature Controller

BR6A Refrigeration temperature controller

Specification

Model	BR6A	
Appearance		
W×H×D(mm)	75 X 33 X 69.5	
Power consumption	5 VA max (220 V a.c. 60 Hz)	
Input sensor	Company exclusive sensor (TH-570N) ※ Thermistor (-50.0 ~ 150.0 °C)	
Display accuracy	±1 % of FS ±1 Digit	
Control output (Main Output)	Relay output	Contact composition : 1c, 250 V a.c., 5 A (Resistive load) 10 V d.c. more than (Resistive load 500 Ω min)
Alarm/Defrost	Relay	Contact composition : 1c, 250 V a.c., 5 A (Resistive load)
Control action	Proportional control (P control), ON/OFF control	
Setting method	Digital setting with operation buttons	
Other function	Defrosting Timer, Alarm function, Heating/cooling control	
Ambient temperature	0 ~ 50 °C	
Resistance between wires	Below 10 Ω for each wire	
Ambient humidity	35 - 85 % RH (With no condenssation)	
Weight	120 g	

Suffix code

Model	Code	Description
BR6A -	<input type="checkbox"/> <input type="checkbox"/> <input type="checkbox"/> <input type="checkbox"/> <input type="checkbox"/>	Digital temperature controller (Selective control type in parameter (Proportional or ON/OFF control))
Input	N	Company exclusive sensor (TH-570N) ※ Thermistor
Control output	M	Relay connect output
	S	SSR output (Voltage pulse 12 V d.c.)
Option	0	None
	1	Communication (RS-485, MODBUS ASCII / RTU)
Power supply voltage	P4	100 - 240 V a.c. 50 - 60 Hz
LED color	W	White LED display
	R	Red LED display

BR6 Refrigeration temperature controller

Specification

Model	BR6	
Appearance		
W×H×D(mm)	77 X 35 X 70.5	
Power Voltage	100 - 240 V a.c. 50 - 60 Hz, 10 - 24 V d.c./a.c. 50 - 60 Hz	
Power Consumption	5 VA max(220 V a.c. 60 Hz)	
Input	Thermistor (HANYOUNG NUX exclusive)	
Display accuracy	±1 % of FS ±1 digit	
Control&Auxiliary output	Relay	Form C contact, 250 V a.c. 5 A (Resistive load)
	SSR	Approx 5 V d.c. 500 Ω min (Load resistance)
Control mode	ON / OFF, Proportion	
Setting method	Digital method by up and Down key	
Other function	Defrosting Timer, Alarm function, Heating / cooling control	
Ambient temperature	0 ~ 50 °C	
Ambient humidity	Max. 85 % RH	

Suffix code

Model	Code	Information
BR6-	<input type="checkbox"/> <input type="checkbox"/> <input type="checkbox"/> <input type="checkbox"/>	Digital temperature controller
Control type	F	ON/OFF control
	P	Proportional control
Input	N	Company exclusive sensor (TH-540N) *Thermistor
Control output	M	Relay
	S	SSR (voltage pulse output 5 V d.c.)
Power Supply Voltage	P3	10 - 24 V d.c. / a.c. 50 - 60 Hz
	P4	100 - 240 V a.c. 50 - 60 Hz

Temperature Controller

ED6 Economical Digital temperature controller

Specification

Model	ED6	
Appearance		
W×H×D(mm)	77 X 35 X 70.5	
Power Voltage	100 – 240 V a.c. 50 – 60 Hz, 10 – 24 V d.c./a.c. 50 – 60 Hz	
Power Consumption	5 VA max(220 V a.c. 60 Hz)	
Input	Thermocouple : K, RTD : Pt100 Ω(IEC751)	
Display accuracy	±1 % of FS ±1 digit	
Control&Auxiliary output	Relay	SPDT(Form C contact) 250 V a.c. 5 A (Resistive load)
	SSR	Approx 5 V d.c. 500 Ω min (Load resistance)
Control mode	ON / OFF or Proportional	
Setting method	Digital method by up and Down key	
Other function	Defrosting Timer, Alarm function, Heating / cooling control	
Ambient temperature	0 – 50 °C	
Ambient humidity	35 ~ 85 % RH (Without Condensation)	

Suffix code

Model	Code				Information
ED6	<input type="checkbox"/>	<input type="checkbox"/>	<input type="checkbox"/>	<input type="checkbox"/>	Digital temperature controller
Control type	F				ON/OFF control
	P				Proportional control
Input	K				Thermocouple K
	P				RTD Pt100 Ω (IEC)
	C				4 – 20 mA d.c. (attach 250 Ω of external resistance), 1 – 5 V d.c.
Control output	M				Relay
	S				SSR (voltage pulse output 5 V d.c.)
Optional	A				Alarm or defrosting timer
	N				NONE
Power Supply Voltage	P3				10 – 24 V d.c. / a.c. 50 – 60 Hz
	P4				100 – 240 V a.c. 50 – 60 Hz

HD6 Economical Digital temperature controller

Specification

Model	HD6	
Appearance		
W×H×D(mm)	77 X 35 X 70.5	
Power Voltage	100 – 240 V a.c. 50 – 60 Hz, 10 – 24 V d.c./a.c. 50 – 60 Hz	
Power Consumption	5 VA max (220 V a.c. 60 Hz)	
Input	Thermistor(HANYOUNG NUX exclusive)	
Display accuracy	±1 % of FS ±1 Digit	
Control output (Relay contact)	From A contact X 2, 250 V a.c. (Resistive load)	
Control mode	ON/OFF control	
Setting method	Digital method by up and Down key	
Other function	Output for motor control of operation/closing window of green house	
Ambient temperature	0 ~ 50 °C	
Ambient humidity	35 ~ 85 % RH (without dew condensation)	





Suffix code

Model	Code				Information
HD6	<input type="checkbox"/>	<input type="checkbox"/>	<input type="checkbox"/>	<input type="checkbox"/>	Economical digital temperature controller
Control type	F				ON/OFF control
Input	N				Company exclusive sensor (TH-540N) *Thermistor
Control output	M				Relay
Power Supply Voltage	P4				100 – 240 V a.c. 50 – 60 Hz

Temperature Controller

■ HY series Economical digital temperature controller

■ Specification

Model	HY-8000S	HY-8200S	HY-72D	HY-48D
Appearance				
W×H×D(mm)	96 X 96 X 125	96 X 96 X 125	72 X 72 X 110	48 X 48 X 100
Power Voltage	110 / 220 V a.c. (50 / 60 Hz)			
Power Consumption	3 VA			
Input	Input(Sensor type) selection by the configuration suffix code. a) Thermo couple : K, J, R b) RTD : KP100 Ω(KS), Pt100 Ω(IEC 751) c)DC current : 4 to 20 mA d) DC voltage : 1 to 5 V d.c.			
Control Output	Relay contact : 250 V a.c. 3 A (Resistive load), SSR: 12 V d.c. (Constant voltage pulse) [Load resistance min. 800 Ω], Current: 4 – 20 mA d.c. [Load resistance max. 600 Ω]			
Control action	Proportional or ON/OFF control			
Alarm Output	–	Relay contact : 250 V a.c. 3 A	–	–
Setting Method	By B,C,D S/W			
Indication range	Setting temperature range			
Display	LED Display			
Setting and display accuracy	Set Value : ±1.0 % of FS, Display : ±0.5 % of FS			
Control sensitivity	Approx 0.2 % FS (Fixed)			
Proportional Cycle	Relay contact : 25 ~ 30 sec SSR : 2 ~ 4 sec			
Reset Range	Max. ±1.5 % of Range			
Dielectric Strength	2,000 V a.c. 50/60 Hz for 1 minute (Primary terminal–secondary terminal)			
Vibration	Malfunction Resistance	2 – 55 Hz, X·Y·Z each position for 10 minutes		
	Mechanical Durability	10 – 55 Hz, 0.76 mm, X·Y·Z each positions for 2 hours		
Shock	Malfunction Resistance	100 % 6 positions, each 3 times		
	Mechanical Durability	300 % 6 positions, each 3 times		
Life	Mechanical	Min.10 million times (Relay type)		
	Electrical	Min. 0.3 million times (Relay type)		
Ambient temperature and humidity		0 ~ 50 °C (32 ~122 °F) 35 ~ 85 % RH (Without freeze)		

■ Suffix Code

Model	Code	Information
HY-	<input type="checkbox"/> <input type="checkbox"/> <input type="checkbox"/> <input type="checkbox"/> <input type="checkbox"/> <input type="checkbox"/> <input type="checkbox"/>	Digital temperature controller
Dimension	8000S	96 X 96 mm
	8200S	96 X 96 (alarm setting general specification)
	72D	72 X 72
	48D	48 X 48
Control type	F	ON/OFF control
	P	Proportional control
Input	K	K thermocouple
	J	J thermocouple
	R	R thermocouple
	D	RTD KPt 100 Ω
	P	RTD Pt 100 Ω (IEC)
	V	1 – 5 V d.c.
	C	4 – 20 mA d.c.
Control output	M	Relay
	C	Current output (4 – 20 mA d.c.)
	S	SSR (voltage pulse output, 12 V d.c.)
Alarm output	N	None
	O	High alarm (HY-8200S)
Control action(Internal selection)	R	Reverse action (heating control)
	D	Direct action (cooling control)
Range code		Refer to the range and input code



■ Range and input code chart

Classification	Code	HY-8000S, 8200S		HY-72D		HY-48D			
		Input type	Range (°C)	Input type	Range (°C)	Input type	Range (°C)		
Thermocouple	4	–	–	–	–	K, J	0 ~ 299		
	5	–	–	–	–		0 ~ 399		
	6	K, J	0 ~ 199	K, J	0 ~ 199	–	–		
	7		0 ~ 299		0 ~ 299				
	8		0 ~ 399		0 ~ 399				
	9		–		0 ~ 599				
	10	0 ~ 599	0 ~ 799						
	11	0 ~ 799	–						
	12	–	0 ~ 1199						
	13	0 ~ 1199	R	600 ~ 1699					
	14	R	600 ~ 1699	–	–				
	RTD	1	–	–	–			Pt100 Ω	–49 ~ 49
		2	–	–99 ~ 99	–99 ~ 99				–99 ~ 99
		3	–	–99 ~ 199	–99 ~ 199				0 ~ 199
4		–	0 ~ 99	0 ~ 99	0 ~ 299				
5		Pt100 Ω	–	Pt100 Ω	–				0 ~ 399
6		–	0 ~ 199	–	0 ~ 199				
7		–	0 ~ 299	–	0 ~ 299				
8		–	0 ~ 399	–	0 ~ 399				
Voltage/ current (DC)	–	1 – 5 V	0 ~ 99	1 – 5 V	0 ~ 99	1 – 5 V	0 ~ 99		
	–	4 – 20 mA	0 ~ 99	4 – 20 mA	0 ~ 99	4 – 20 mA	0 ~ 99		

Temperature Controller

DF series Economical digital temperature controller

Specification

Model	DF2	DF2(SUB)	DF4
Appearance			
W×H×D(mm)	48 X 96 X 100	48 X 96 X 100	48 X 48 X 100
Power voltage	110 / 220 V a.c. (50/60 Hz)		220 V a.c. (110 V, option)
Power consumption	3 VA	4 VA	3 VA
Input	See range and input code chart(TC, RTD, 4 to 20 mA d.c., 1 to 5 d.c.) ※ Range(0 to 99) of Current and voltage input		
Control output	Relay contact : 250 V a.c. 3 A (Resistive load), SSR : 12 V d.c. (constant voltage pulse) (Load resistance min. 800 Ω), Current: 4 – 20 mA d.c. (Load resistance max. 600 Ω)		
Control action	–	Proportional or ON/OFF control	–
Alarm	Relay contact : 250 V a.c. 3 A		
Setting	By BCD S/W		
Display range	Setting value		
Display	Digital indicator		
Setting and display accuracy	Display ±0.5 % of FS Range, Max. Set value ±1.0 % of FS		
Hysteresis	0.2 % FS (fixing), ON/OFF control.		
Proportional cycle	Relay contact : 25 ~ 30 sec SSR : 2 ~ 4 sec		
Reset range	±1.5 % of Max. Range		
Dielectric strength	2,000 V a.c. 50/60 Hz for 1 minute (Primary terminal–secondary terminal)		
Vibration	Malfuction Resistance	2 – 55 Hz, X, Y, Z each position for 10 minutes	
	Mechanical Durability	10 – 55 Hz, 0.76 mm, X, Y, Z each position for 2 hours	
Shock	Malfuction Resistance	100 % 6 positions, Each 3 times	
	Mechanical Durability	300 % 6 positions, Each 3 times	
Life	Mechanical	More than 10 million times	
	Electrical	More than 0.3 million times	
Ambient temperature and humidity	0 ~ 50 °C(32 ~ 122 °F) 35 ~ 85 % RH (Without condensation)		

Temperature Controller

Recorder

Digital Counter
Timer

Analog
Timer

Panel
Meter

Multi Pulse
Meter

Proximity
Sensor

Photo
Sensor

Rotary
Encoder

Thyristor
Power
Regulator

Solid
State
Relay

Power
Supply

Control
Switch

Push Button /
Main
Switch

Cam Switch /
Limit
Switch

Micro /
Hoist
Switch

Foot /
Mono Lever
Switch

Signal
Light

Terminal Block /
Power Buzzer /
Fuse Holder /
Control Box

Suffix code

Model	Code	Information
DF	<input type="checkbox"/> - <input type="checkbox"/> <input type="checkbox"/> <input type="checkbox"/> <input type="checkbox"/> <input type="checkbox"/>	Economical digital temperature controller
Dimension	2	48(W) X 96(H) mm
	4	48(W) X 48(H) mm (socket type, 8 pin)
Control type	F	ON/OFF control
	P	Proportional control
Input	K	K thermocouple
	J	J thermocouple
	D	RTD KPt100 Ω
	P	RTD Pt100 Ω (IEC)
	V	1 – 5 V d.c.
	C	4 – 20 mA d.c.
Control output	M	Relay
	C	Current output (4 – 20 mA d.c.)
	S	S.S.R (voltage pulse output, 12 V d.c.)
Auxiliary output (SUB) ※ only with DF2	N	None
	O	High deviation
	P	Low deviation
	W	High/Low deviation
Control action (internal selection)	R	Reverse action (heating control)
	D	Direct action (cooling control)
Range code		Refer to the range and input code

※ Model DF4 selects proportional control/ON–OFF control by using internal dip switch.

※ Model DF4 with 110 V power voltage is available as order–made.

Range and input code chart

Classification	Code	DF2		DF4	
		Input type	Range (°C)	Input type	Range (°C)
Thermocouple	4	K, J	–	K, J	0 ~ 199
	5		0 ~ 199		0 ~ 299
	6		0 ~ 299		0 ~ 399
	7		0 ~ 399		0 ~ 599
RTD	8	Pt100 Ω	–	Pt100 Ω	0 ~ 799
	1		–99 ~ 99		–
	2		–		–99 ~ 99
	3		–		0 ~ 99
	4		0 ~ 99		0 ~ 199
	5		0 ~ 199		0 ~ 299
	6		0 ~ 299		0 ~ 399
7	0 ~ 399	–			
DC voltage	–	1 – 5 V	0 ~ 99	1 – 5 V	0 ~ 99
DC current	–	4 – 20 mA	0 ~ 99	4 – 20 mA	0 ~ 99

Temperature Controller

RS6 Digital temperature controller

Specification

Model	RS6
Appearance	
W×H×D(mm)	72 X 36 X 76
Power Supply Voltage	12 V a.c. 60 Hz
Power Consumption	5 VA max
Input Sensor	Pt100 Ω(IEC751), NTC(Company exclusive)
Display accuracy	±1 % of FS ±1 Digit
Output (Relay contact)	Control output : From C contact, 250 V a.c. 3A(Resistive load), Alarm output : From A x 2, 250 V a.c. 3A (Resistive load)
Control mode	Only for ON/OFF control
Setting method	Digital method by up and Down key
Other function	Reverse action (heating) or direct action (cooling) selection
Ambient temperature	0 ~ 50 °C
Ambient humidity	35 ~ 85 % RH (without dew condensation)

Suffix code

Model	Code	Information
RS6	<input type="checkbox"/>	Digital temperature controller
Input	K	K thermocouple
	P	RTD Pt100 Ω (IEC)
	N	Company exclusive NTC

TP3 5 channel digital indicator

Specification

Model	TP3
Appearance	
W×H×D(mm)	96 X 48 X 100
Power Supply Voltage	100 – 240 V a.c. (±10 %) 50 – 60 Hz
Power consumption	Max. 5 VA
Input	Thermocouple : K, J, RTD : Pt 100 Ω (IEC)
Display accuracy	Thermocouple : ±0,5 % of display value ±1 digit or ±3 °C RTD : ±0,5 % of display value ±1 digit or ±2 °C
Control operation	Indicator only (5 channels)
Setting method	Digital method by setting key
Function	1 to 5 channel display by automatic or fixed 1 channel
	Offset correction for each channel
Ambient Temp. / Humidity	Max. 0 °C ~ 50 °C / 35 ~ 85 % RH

Suffix code

Model	Code	Information
TP3 –	<input type="checkbox"/> : <input type="checkbox"/>	5 channel indication thermometer 96(W) X 48(H)
Input	K	K thermocouple
	J	J thermocouple
	P	Resistance Temperature Detector(RTD) Pt 100 Ω (IEC)
Power Supply Voltage	P4	100 – 240 V a.c. 50 – 60 Hz

Temperature Controller

■ BK6-M Multi input digital indicator

■ Specification

Model	BK6-M	
Appearance		
W×H×D(mm)	72 X 36 X 86	
Power Supply Voltage	100 – 240 V a.c. 50 – 60 Hz	
Input	Multi input	Thermocouple : K, J, E, T, R, B, S, L, N, U, W, PLII RTD : Pt100 Ω(IEC), KPt100 Ω(KS)
Display accuracy	±0.5 % of FS ±1 digit	
Voltage fluctuation	±10 % of power supply voltage	
Power consumption	4 VA max	
Ambient temperature	0 ~ 50 °C (Without condensation)	
Ambient humidity	35 ~ 85 % RH	
Storage temperature	-25 ~ 65 °C (Dew condensation)	

■ Suffix code

Model	Code	Information
BK6-M	<input type="checkbox"/>	Multi input digital indication thermometer
Optional	0	None
	1	RET(Retransmission output 4 – 20 mA d.c.)

■ HN100 Digital indicator

■ Specification

Model	HN100	
Appearance		
W×H×D(mm)	275×170×34.4	
Use	Sauna facility, bathroom, fitness center, hospital, greenhouse, etc temperature display in spacious places	
FND size	24 x 34	
Protection degress	IP57	
Input	RTD : Pt100 Ω(IEC751), DC current : 4 to 20 mA(for 0 to 100 °C)	
Input display accuracy	Full span of ±0.5 % reg ±1 Digit	
Sensor appearance	Waterproof SUS TUBE	
Sensor cable length	1.5 m	
Power cable length	1.8 m	
Power Voltage	12 V d.c.	



■ Suffix code

Model	Code	Information
HN100-	<input type="checkbox"/> : <input type="checkbox"/>	Digital temperature indicator 275(W)×170(H)
Input	1	Resistance Temperature Detector(RTD) Pt100 Ω
	2	4 – 20 mA d.c. (measurement range 0 ~ 100 °C fixed)
Measurement range	1	-100 ~ 400 °C
	2	-19.9 ~ 99.9 °C

Temperature Controller

■ AT series Digital indicator

■ Specification

Model	AT3	AT6
Appearance		
W×H×D(mm)	96 X 48 X 100	72 X 36 X 95
Power Voltage	110 / 220 V a.c. (50/60 Hz)	100 – 240 V a.c. (50 – 60 Hz)
Power Consumption	4 VA	5 VA
Input	K thermocouple, RTD Pt 100 Ω, R thermocouple	K thermocouple, J thermocouple, RTD : Pt100 Ω(IEC) –199 ~ 600 °C, RTD : Pt100 Ω(IEC) –199.9 ~ 199.9 °C, DC voltage : G (0 – 5 V d.c.), V (1 – 5 V d.c.), F (0 – 10 V d.c.), DC current : C (4 – 20 mA d.c.)
Permissible input resistance	TC : 100 Ω max., RTD : 10 Ω max.	
Display accuracy	Max. 0.5 % of Max. range	
Display	Digital indicator	
Dielectric strength	2,000 V a.c. 50/60 Hz for 1 minute(Between + and – charged terminals)	
Vibration	Malfuction Resistance	2 – 55 Hz, X-Y-Z each position for 10 minutes
	Mechanical Durability	10 – 55 Hz, 0.76 mm, X-Y-Z each position for 2 hours
Shock	Malfuction Resistance	100 % 6 positions, Each 3 time (Approx. 10 G)
	Mechanical Durability	300 % 6 positions, Each 3 time (Approx. 30 G)
Ambient temperature and humidity	0 ~ 50 °C 35 ~ 85 %RH (without condensation)	

■ Suffix code

Model	Code	Information
AT	<input type="checkbox"/> – : <input type="checkbox"/>	Digital Temperature Indicator
Dimension	6	72 (W) × 36 (H) mm
	3	96 (W) × 48 (H) mm
AT3	KP	K thermocouple, RTD Pt 100 Ω
	R	R thermocouple
AT6	K	K thermocouple
	J	J thermocouple
	P1	Resistance Temperature Detector(RTD) Pt100 Ω(IEC) –199 ~ 600 °C
	P2	Resistance Temperature Detector(RTD) Pt100 Ω(IEC) –199.9 ~ 199.9 °C
	G	0 – 5 V d.c.
	V	1 – 5 V d.c.
	F	0 – 10 V d.c.
	C	4 – 20 mA d.c.

■ BK3 Digital indicator

■ Specification

Model	BK3
Appearance	
W×H×D(mm)	96 X 48 X 100.2
Power Voltage	110/220 V a.c. 50/60 Hz (dual usage)
Power Consumption	4 VA max
Input	Input(Sensor type) selection by the configuration suffix code. a) Thermo couple : K, J, R b) R.T.D : Pt100 Ω(IEC), c) DC current : 4 to 20 mA (for 0 to 100 °C). e) DC voltage : 0 to 5 V, 0 to 10 V, 1 to 5 V d.c.(for 0 to 100 °C)
Display accuracy	±0.5 % of FS ±1 Digit (But, input type R is not applicable in the range of below 599 °C)
Ambient temperature	0 ~ 50 °C
Storage temperature	–25 ~ 65 °C



■ Suffix code

Model	Code	Information
BK3–	<input type="checkbox"/>	Digital Temperature Indicator 96(W) X 48(H)
Input	K	K thermocouple (refer to the range and input code chart)
	K1	
	J	J thermocouple
	R	R thermocouple
	P1	Resistance Temperature Detector(RTD)
	P2	Pt100 Ω (refer to the range and input code chart)
	G	0 – 5 V d.c.
	V	1 – 5 V d.c.
	F	0 – 10 V d.c.
	C	4 – 20 mA d.c.

Temperature Controller

■ HY-4500S / 4700S / 5000 Analog indication temperature controller

Specification

Model	HY-4500S	HY-4700S	HY-5000
Appearance			
W X H X D (mm)	96 X 96 X 125	96 X 96 X 125	72 X 72 X 110
Power voltage	100 / 220 V a.c. (50/60 Hz)		
Power Consumption	3 VA	3 VA	3 VA
Input	Input(Sensor type) selection by the configuration suffix code. a) Thermo couple : K, J, R. b) R.T.D : KPt100 Ω(KS), Pt100 Ω(IEC751). c) DC current : 4 to 20 mA (for 0 to 100 °C). e) DC voltage : 1 to 5 V d.c.(for 0 to 100 °C)		
Control output	Relay contact : 250 V a.c. 3 A (Resistive load), SSR: 12 V d.c. (Constant voltage pulse) (Load resistance 800 Ωmin), current output: 4 – 20 mA d.c. (Load resistance 600 Ωmax)		
Control action	Proportional or ON/OFF contact		
Alarm output	–	Relay contact: 250 V a.c. 3 A(Resistive load)	–
Control sensitivity	±0.2 % of FS		
Setting	Volume		
Display	Meter		
Setting and display accuracy	The same as SV, ±2.0 % of FS		
Alarm setting range	–	Within 1~10% of Max. range for operation point of SV	–
Proportional cycle	Relay contact : 25 ~ 30 sec , SSR : 2 ~ 4 sec		
Reset range	±1.5 % of FS		
Dielectric strength	2,000 V a.c. for 1 minute		
Ambient temperature and humidity	0 ~ 50 °C(32 ~ 122 °F)-35 ~ 85 % RH (Without condensation)		

Suffix code

Model	Code						Information
HY-	<input type="checkbox"/>	<input type="checkbox"/>	<input type="checkbox"/>	<input type="checkbox"/>	<input type="checkbox"/>	<input type="checkbox"/>	Analog indication temperature controller
Dimension	4500S						96(W) X 96(H)
	4700S						96(W) X 96(H) (auxiliary output: L,M)
	5000						72(W) X 72(H)
Control type	F						ON/OFF control (2 position control)
	P						Proportional control
Input	K						K thermocouple
	J						J thermocouple
	R						R thermocouple
	D						Resistance Temperature Detector(RTD) KPt100 Ω
	P						Resistance Temperature Detector(RTD) Pt100 Ω(IEC)
	V						1 – 5 V d.c.
Control output	C						4 – 20 mA d.c.
	M						Relay
	C						Current output (4 – 20 mA d.c.)
	S						SSR (12 V d.c. voltage pulse output)
Sub output (L,M) (apply only with the model HY-4700)	N						NONE
	O						Low action
	P						High action
	W						Low/High action
Control operation	R						Reverse action (heating control)
	D						Direct action (cooling control)
Range code							Refer to the "Range and input code chart"



Range and input code chart

Code	HY-4500S, HY-4700S		HY-5000	
	Input type	Range (°C)	Input type	Range (°C)
1	Pt100 Ω	-50 ~ 50	Pt100 Ω	-50 ~ 50
3	Pt100 Ω	-50 ~ 100	Pt100 Ω	-0 ~ 100
5	Pt100 Ω	0 ~ 100	K, Pt100 Ω	0 ~ 200
6	–	–	K, Pt100 Ω	0 ~ 300
7	K, Pt100 Ω	0 ~ 200	K, Pt100 Ω	0 ~ 400
8	K, Pt100 Ω	0 ~ 300	K	0 ~ 600
9	K, J, Pt100 Ω	0 ~ 400	K	0 ~ 800
10	K	0 ~ 600	K	0 ~ 1200
11	K	0 ~ 800	–	–
13	K	0 ~ 1200	–	–
14	R	0 ~ 1600	–	–

Temperature Controller

■ HY-3000, AF1 Deviation indicating temperature controller

■ Specification

Model	HY-3000	AF1	AF1(SUB)
Appearance			
W×H×D(mm)	96 X 96 X 104	48 X 96 X 100	48 X 96 X 100
Power voltage	100 / 220 V a.c. 50/60 Hz		
Power Consumption	3 VA		
Input	Input(Sensor type) selection by the configuration suffix code. a) Thermo couple : K, J b) RTD : Pt100 Ω(IEC751), c) DC current : 4 to 20 mA (for 0 to 100 °C) e) DC voltage : 1 to 5 V d.c.(for 0 to 100 °C)		
Control output	Relay contact : 250 V a.c. 5 A (Resistive load), SSR : 12 V d.c. (Constant voltage pulse) (Load resistance more than 800 Ω)		
Control action	Proportional or ON/OFF control		
Alarm output	-		Relay contact : 250 V a.c. 5 A
Alarm setting	-		Variation setting for SV
Setting	Volume	BCD switch	
Display range	-50 ~ 50 °C		
Display	Meter		
Setting and display accuracy	Setting temperature: within ±2 % of FS, Display accuracy : Within ±2.5 % of FS		
Proportional band	3 % of FS (Fixing)		
Proportional cycle	Relay contact : 25 ~ 30 sec SSR : 2 ~ 4 sec		
Reset range	±1.5 % of FS (Primary terminal-secondary terminal)		
Dielectric strength	2,000 V a.c. 50/60 Hz for 1 minute		
Ambient temperature and humidity	0 ~ 50 °C (32 ~ 122 °F) 35 ~ 85 % RH (without condensation)		

■ Suffix code

Model	Code	Information
HY-1000	<input type="checkbox"/> <input type="checkbox"/> <input type="checkbox"/> <input type="checkbox"/> <input type="checkbox"/>	96X96
AF1	<input type="checkbox"/> <input type="checkbox"/> <input type="checkbox"/> <input type="checkbox"/> <input type="checkbox"/>	48X96
Control type	F	ON/OFF control (2 position control)
	P	Proportional control
Input	K	K thermocouple
	J	J thermocouple
	P	Resistance Temperature Detector(RTD) Pt100 Ω(IEC)
	V	1 - 5 V d.c.
	C	4 - 20 mA d.c.
Control output	M	※ Relay
	C	※ Current output (4 - 20 mA d.c.)
	S	SSR (12 V d.c. voltage pulse output)
Sub output(SUB) (only with model AF1)	N	※ NONE
	O	※ High action
	P	Low action
	W	※ High/Low action
Control operation	R	※ Reverse action (heating control)
	D	※ Direct action (cooling control)
Range code		Refer to the "Range and input code chart"

※ Applied only to the AF1





■ Range and input code chart

Code	HY-3000		AF1	
	Input type	Range (°C)	Input type	Range (°C)
1	-	-	Pt100 Ω	-99 ~ 99
3	Pt100 Ω	-50 ~ 100	-	-
4	K, J, Pt100 Ω	0 ~ 100	Pt100 Ω	0 ~ 99
5	K, J, Pt100 Ω	0 ~ 200	K, Pt100 Ω	0 ~ 199
6	K, J, Pt100 Ω	0 ~ 300	K, Pt100 Ω	0 ~ 299
7	K, J, Pt100 Ω	0 ~ 400	K, Pt100 Ω	0 ~ 399
8	K	0 ~ 600	-	-
9	K	0 ~ 800	-	-
11	K	0 ~ 1200	-	-

Temperature Controller

■ HY-2000, HY-1000, ND4 Non-indicating temperature controller

Specification

Model	HY-2000	HY-1000	ND4	ND4(For socket)
Appearance				
W×H×D(mm)	96 X 96 X 104	72 X 72 X 100	48 X 48 X 80	48 X 48 X 78
Power voltage	110 /220V a.c. 60 Hz			
Power consumption	3VA			
Input	Thermocouple : K, J RTD : Pt100 Ω(IEC751)			
Control Output	Relay contact : 250 V a.c. (Resistive load)			
Control action	Proportional or ON/OFF control			
Setting	Volume			
Setting and display accuracy	±1.0 % of FS			
Proportional band	1 ~ 10 % of FS (HY-4500) (Model HY-4700, HY-5000 fixing to 3% of FS)			
Proportional cycle	Relay contact : 25 ~ 30 sec.			
Dielectric strength	2,000 V a.c. 50/60 Hz for 1 minute (Primary terminal-secondary terminal)			
Ambient temperature and humidity	0 ~ 50 °C (32 ~ 122 °F) 35 ~ 85 % RH (without condensation)			

Suffix code

Model	Code	Information
HY-1000		72(W) X 72(H) mm
HY-2000	<input type="checkbox"/> <input type="checkbox"/> <input type="checkbox"/> <input type="checkbox"/> <input type="checkbox"/> <input type="checkbox"/> <input type="checkbox"/>	96(W) X 96(H) mm
ND4		48(W) X 48(H) mm
Control type	F	ON/OFF control (2 position control)
	P	Proportional control
Input	K	K thermocouple
	J	J thermocouple
	P	Resistance Temperature Detector(RTD) Pt100 Ω(IEC751)
Control output	M	Relay
Alarm output	N	None (*.Model ND4 does not display)
Control action	R	Reverse action (heating control)
	D	Direct action (cooling control)
Range code		Refer to the "Range and input code chart"
Terminal	T	ND4 terminal type

※ ND4 : Please select power voltage (110 V a.c. or 220 V a.c.)

Range and input code chart

Code	HY-2000		HY-1000		ND4	
	Input type	Range (°C)	Input type	Range (°C)	Input type	Range (°C)
1	—	—	Pt100 Ω	-50 ~ 50	Pt100 Ω	-50 ~ 50
2	Pt100 Ω	-50 ~ 100	—	—	Pt100 Ω	-100 ~ 100
3	—	—	Pt100 Ω	0 ~ 100	Pt100 Ω	0 ~ 100
4	K, J, Pt100 Ω	0 ~ 100	—	—	—	—
5	K, J, Pt100 Ω	0 ~ 200	K, Pt100 Ω	0 ~ 200	K, Pt100 Ω	0 ~ 200
6	K, J, Pt100 Ω	0 ~ 300	K, Pt100 Ω	0 ~ 300	K, Pt100 Ω	0 ~ 300
7	K, J, Pt100 Ω	0 ~ 400	K, Pt100 Ω	0 ~ 400	K, Pt100 Ω	0 ~ 400
8	K	0 ~ 600	K	0 ~ 600	—	—
9	K	0 ~ 800	K	0 ~ 800	—	—
10	—	—	K	0 ~ 1200	—	—
11	K	0 ~ 1200	—	—	—	—

Temperature Controller

■ D55 Portable thermometer

Specification

Model	D55
Appearance	
W×H×D(mm)	71 X 158 X 32
Power Supply Voltage	9 V d.c.
Input	K, J
Display method	LCD digital
Display accuracy	±0.5 % of FS
Measuring range	-200.0 ~ 1370.0 °C
Ambient temperature and humidity	0 ~ 50 °C(32 ~122 °F) 35 ~ 85 % RH (without condensation)

Thermocouple

• TC-PJP

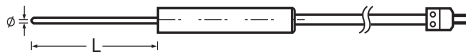

• TC-PIP

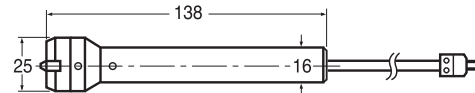

• TC-PLP

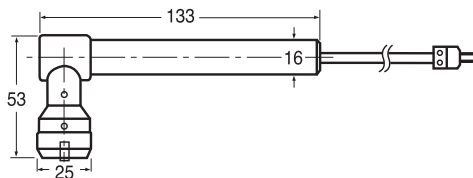

• TC-POP

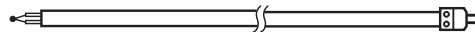

■ EM310 Data storage device



Specification

Model	EM310
Appearance	
Power voltage	24 V d.c., 500 mA
Communication type	Asynchronous type serial communication (RS232C)
Communication speed	38400 bps
Communication distance	Max 5 m
Setting type	Set by front switch
Saving media	USB MEMORY STICK
File system	Support FAT16, 32
Internal memory	32 Mbyte (Non-volatile)

Temperature Controller

■ HMCW-103 Wi-Fi_to_Serial Converter

Specification

Model	HMCW-103
Appearance	
CPU	PIC32MX695F512L
Memory	SRAM : 128 Kbit, Flash : 512 Kbit
Input Voltage	5 V d.c. (±10 %)
Maximum Current	Maximum under 250 mA
RS-232 Communication	Data communication / Serial console Male DB9 Serial Port Communication speed : 4800 ~ 115200bps Flow control: None Signal : TX, RX, GND
RS-485 Communication	For 2 and half wires and duplex method for data communication Communication speed : 4800 ~ 115200bps Flow control : DE/RE Signal : TX+, TX-
RS-422 Communication	4 wires and duplex method for data communication Communication speed : 4800 ~ 115200bps Flow control : None Signal : TX+, RX+, TX-, RX-
Ethernet Communication	Wi-Fi fluid IP support It is possible to access a lot of Clients (maximum 3 devices) ARP, IP/ICMP, TCP, Telnet, DHCP support
Configuration	Telnet or Serial Console Interface
LED	Power Supply Input mark Activating Condition Mark
Weight	74 g
Ambient Temperature	-10 °C ~ 60 °C
Storage temperature	-30 °C ~ 80 °C
Certification Standard	 MSIP-CRM-NUX-HMCW-103
Warranty period	1 year

■ CV300 Communication converter



Specification

Model	CV300
Appearance	
Power	9 V, 300 mA d.c. Adapter (1.3 Ø DC Jack)
Communication speed	2400 ~ 115200 bps
Communication distance	1.5km max and possible to connect max 256 devices
Safety	1/2 circuit insulation, built in the surge protective device, automatically forms ±15 KV ESD Protection Line Drive signal
Function setting	2 wires/4 wires, usage of the built in terminating resistance, full duplex/half duplex setting Possible
Connection method	RS232 → DB-9 Female (possible to connect directly to the serial port of PC), RS422/485 → method of inserting communication wire to the 4 pin terminal block.
Switch setting	6 Pin Piano Type Dip-Switch
Case material	Made of plastic
Weight	Body : 60 g, Adapter 300 g
Dimension	52 x 90 x 20 mm

Temperature Controller



■ HMCE-103 Ethernet_to_Serial Converter

■ Specification

Model	HMCE-103	
Appearance		
CPU	PIC32MX695F512L	
Memory	SRAM : 128 Kbit, Flash : 512 Kbit	
Input Voltage	5 V d.c. (±10 %)	
Maximum Current	Maximum under 200 mA	
RS-232 Communication	Data communication / Serial console Male DB9 Serial Port	
	Communication speed : 2400 ~ 115200 bps	
	Flow control : None Signal : TX, RX, GND	
RS-485 Communication	For 2 and half wires and duplex method for data communication	
	Communication speed : 2400 ~ 115200 bps	
	Flow control : DE/RE Signal : TX+, TX-	
RS-422 Communication	4 wires and duplex method for data communication	
	Communication speed : 2400 ~ 115200 bps	
	Flow control : None Signal : TX+, RX+, TX-, RX-	
Ethernet Communication	10/100 Base-T Ethernet (RJ-45 Connector)	
	Fixed and fluid IP support	
	Multi-client access (maximum 3 devices)	
	ARP, IP/ICMP, TCP, Telnet, DHCP	
Configuration	Telnet or Serial Console Interface	
LED	Power Supply Input mark Activating Condition Mark	
Weight	74 g	
Ambient Temperature	-10 °C ~ 60 °C	
Storage temperature	-30 °C ~ 80 °C	
Certification Standard	 KCC-REM-NUX-HMCE-103	
Warranty period	1 year	

■ CV250 Dry/wet type temperature/humidity converter

■ Specification

Model	CV250	
Appearance		
Power Supply Voltage	100 / 240 V a.c., 50 - 60 Hz	
Power consumption	Approx. 3 VA	
Input signal	Resistance Temperature Detector(RTD) : Pt100 Ω (IEC751), dry/wet each 1 example ※ Dry/Wet transmitter (Company model HY-PT230)	
Measurement range	Temperature : 0 ~ 100 °C, Humidity : 0 ~ 100 % RH	
Accuracy	Temperature : ±0.5 %, Humidity : ±1 %	
Output signal	Temperature/humidity yields 1 output individually (current by the suffix code/voltage output selectable) 4 - 20 mA d.c. (Load resistance 600 Ω max.), 1 - 5 V d.c. (Load resistance 1 KΩ min)	
Output compensation	±5 % (Off-set compensation by the variable resistance)	
Insulation resistance	Min 20 MΩ (500 V d.c.)	
Dielectric strength	2,500 V a.c. (power terminal-signal input/output terminal)	
Ambient temperature	0 ~ 50 °C	
Ambient humidity	35 ~ 85 % RH (without dew condensation)	
Storage temperature	-25 ~ 65 °C	
Vibration resistance	10 - 55 Hz, single amplitude 0.76 mm, for 1 min each in 3 axis direction	
Shock resistance	300 %, 6 directions each 3 times	
Weight	Approx. 300 g	



■ Suffix code

Model	Code	Information
CV250-	<input type="checkbox"/>	Temperature/Humidity converter
Output signal	C	4 - 20 mA d.c.
	V	1 - 5 V d.c.

Recorder

■ GR200 Graphic recorder with touch panel function

■ Specification

Model		GR200
Appearance		 
W×H×D(mm)		144 (W) × 144 (H) × 173.5 (D)
Power supply voltage		100 – 240 V a.c. (voltage fluctuation : ±10 %)
Power frequency		50 – 60 Hz
Power consumption		max 22 VA
Input	Channel	2 Channels, 4 channels, 8 Channels, 12 Channels
	Input type	RTD 2 type (Pt-100, KPt-100), Thermocouple 12 type (K, J, E, T, R, B, S, L, N, U, Wre 5-26, PL-II), DC voltage 4 type (-10 – 20 mV, 0 – 100 mV, 1 – 5 V, 0 – 30 V)
	Sampling time	250 ms
	Accuracy	±0.15 % of FS ±1 digit (Except RJC temperature error)
	RJC temperature error	±1.5 °C (0 ~ 50 °C)
	Burn-out	Display UP-Scale
Alarm	Alarm setting	2 settings within each channel
	Alarm type	High/Low, Alarm within high/low range, Alarm without high/low range etc.
Save function	Internal memory	Non-volatile flash memory (80 MB) : In case of 1 second of record cycle, It saves data for 15 days
	External memory	SD card (2GB) : In case of 1 second of record cycle, it saves data for 1 year. (Support SDHC)
	File type	FAT 16/32 (SD card)
	Record cycle	1, 2, 5, 10, 20, 30, 60, 120 sec
	LIST	Display important event messages in the trend view
Display	Indicator	TFT color LCD (115.2 mm × 86.4 mm, 640 × 480 pixel) LED Backlight
	Language	Korean, English, Chinese
	Screen setting	Trend view, Text view, Bar view
	Save history view	Check saved data and Provide zoom in & zoom out function
DI (Option)	External direct input (DI)	2 contacts, 4 contacts
	Input type	Non-voltage contact input
Output (Option)	Contact output	6 contacts, 12 contacts (NO)
	Contact capacity	3 A 250 V a.c. (3 A 30 V d.c.)
Weight		Approx. 1.3 kg

■ Suffix code

Model	Code	Information
GR200 –	<input type="checkbox"/> <input type="checkbox"/> <input type="checkbox"/>	Graphic recorder(applied touch panel function) 145(W) × 145(H) mm
Input channel	2	2 channels
	4	4 channels
	8	8 channels
	12	12 channels
Input / Output (DI / DO)	N	None
	1	DI 2 Contact + Relay 6 Contact
	2	DI 4 Contact + Relay 12 Contact
Communication specification	0	RS422/485

RT9 Mini recorder

Specification

Model	RT9
Appearance	
W×H×D(mm)	96 X 96 X 100
Function	• ZOME • PID–Auto Tuning • Prescale • Multi Input/Output • Alarms • Recorder/Temp.controller
Power voltage	100 – 240 V a.c. (±10 %), 50/60 Hz
Power consumption	Max. 6.0 W, Max. 10 VA
Sampling cycle	250 ms
Input	T.C: K, J, E, T, R, S, B, L, N, U, WRe 5 – 26, PL–II R.T.D: Pt 100 Ω, KPt 100 Ω Direct voltage: 1 – 5 V, 0 – 10 V, –10 – 20 mV, 0 – 100 mV(Prescale type)
Input display resolution	Below decimal point of input signal and measuring range
Input impedance	TC and mV input: Min. 1 MΩ, DC volt : 1 MΩ
Alarm	Relay output(AL1,AL2)
Source tolerable resistance	TC : Max . 250 Ω , Voltage : Max . 2 kΩ
Lead wire tolerable resistance	R.T.D : Max . 10 Ω / Wire (Notice:Identical conductor resistance between 3wires)
Input tolerable voltage	±10 V (TC, RTD, voltage : mV d.c.), ±20 V (voltage : V d.c.)
Noise removal rate	NMRR(Normal mode) : Min. 40dB , CMRR(Common mode) : Min. 120 dB (50/60 Hz ±1 %)
Standard	TC / RTD (KS/IEC/DIN)
Standard junction temp-compensation tolerance	±1.5 °C (15 ~ 35 °C), ±2.0 °C(0 ~ 50 °C)
Accuracy	±0.3 % (Full Scale)
Record	Measuring point : 1 point, Response time : Variable by recording time, Record method : Thermal line, Printing : 203 dpi (8.0 dot/mm) 384 dots/line Record speed : 24 mm/h ~ 900 mm/h, Record paper : Width 57.5 mm , Length 16 m Runout of paper : P–END lamp on,Record is stopped







Suffix code

Model	Code	Information
RT9–	<input type="checkbox"/> <input type="checkbox"/> <input type="checkbox"/>	Mini recorder 96(W) × 96(H) mm
Control type	0	Exclusive for recorder
	1	Record and temperature control
Unit selection	0	(°C) Celsius(only)
	1	Etc
Optional	0	None
	1	Alarm output 1 contact (AL1)
	2	Alarm output 2 contact (AL1, AL2)
	3	Communication (RS485)
	4	Communication (RS485) / alarm 1 contact (AL1)
	5	Communication (RS485) / alarm 2 contact (AL1, AL2)





Digital Counter/Timer

GE series Digital batch counter

Specification

Model	GE6-P4	GE6-P6	GE6-T6	GE4-P4	GE4-P6	GE4-T6
Appearance						
W×H×D(mm)	72 X 36 X 81 (W X H X D)			48 X 48 X 79,3 (W X H X D)		
Type	Preset		Totalizing	Preset		Totalizing
Display digits	4 Digits	6 Digits	6 Digits	4 Digits	6 Digits	6 Digits
Preset stages	1 or 2 Stages	1 or 2 Stages	–	1 or 2 Stages	1 or 2 Stages	–
Function	1 Stages : Preset counter/Timer (Selectable by the internal parameter)					
	2 Stages : Preset counter/Timer/Twin timer (Selectable by the internal parameter)					
	Prescale setting, Batch output, Displaying unit decimal point setting, NPN input/PNP input (Selectable by the internal switch)					
Counting speed	1 cps, 30 cps, 1 kcps, 10 kcps (Selectable by the internal parameter) ※ Input levels : [High] 5 to 30 V d.c. [Low] 0 to 2 V d.c.					
Input action	UP, DOWN, UP/DOWN (Selectable by the internal parameter)					
Output action	N, F, C, R, K, P, Q, A (Selectable by the internal parameter)					
Prescale	Applicable only preset counter, 0.001 ~ 9999(4 digits), 0.00001 ~ 999999(6 digits)					
Power supply voltage	100 to 240 V a.c. (50 to 60 Hz), 24 to 60 V d.c./a.c. (50 to 60 Hz)					
External supplying power	12 V d.c. 100 mA max					
Control output	Contact : 250 V a.c. 3 A (NO), 250 V a.c. 2 A (NC) Solid-state : 30 V 100 mA max (Open collector)					
Communication	Protocol	ModbusRTU				
	Communication type	RS485				
	Communication method	2-wire half-duplex				
	Communication synchronization	Asynchronous				
	Communication speed	2,400 / 4,800 / 9,600 / 19,200 / 38,400 bps				
	Effective distance	Up to 800 m				
	Maximum number of connections	31 units (station number: 1 to 127)				
	Response waiting time	5 ~ 99 ms				
	Start bit	1bit (fix)				
	Stop bit	1bit (fix)				
Data bit	8 bit					
Parity bit	None / Odd / Even					

Digital Counter/Timer

Model	GE3-P6	GE3-T6	GE7-P6	GE7-T6
Appearance				
W×H×D(mm)	96 X 48 X 102.6 (W X H X D)		72 X 72 X 87 (W X H X D)	
Type	Preset	Totalizing	Preset	Totalizing
Display digits	6 Digits		6 Digits	
Preset stages	1 or 2 Stages	–	1 or 2 Stages	–
Function	1 Stages : Preset counter/Timer (Selectable by the internal parameter) 2 Stages : Preset counter/Timer/Twin timer (Selectable by the internal parameter) Prescale setting, Batch output, Displaying unit decimal point setting, NPN input/PNP input (Selectable by the internal switch)			
Counting speed	1 cps, 30 cps, 1 kcps, 10 kcps (Selectable by the internal parameter) ※ Input levels : [High] 5 to 30 V d.c. [Low] 0 to 2 V d.c.			
Input action	UP, DOWN, UP/DOWN (Selectable by the internal parameter)			
Output action	N, F, C, R, K, P, Q, A (Selectable by the internal parameter)			
Prescale	Applicable only preset counter, 0.001 ~ 9999(4 digits), 0.00001 ~ 999999(6 digits)			
Power supply voltage	100 to 240 V a.c. (50 to 60 Hz), 24 to 60 V d.c./a.c. (50 to 60 Hz)			
External supplying power	12 V d.c. 100 mA max			
Control output	Contact : 250 V a.c. 3 A (NO), 250 V a.c. 2 A (NC) Solid-state : 30 V 100 mA max (Open collector)			
Communication	Protocol	ModbusRTU		
	Communication type	RS485		
	Communication method	2-wire half-duplex		
	Communication synchronization	Asynchronous		
	Communication speed	2,400 / 4,800 / 9,600 / 19,200 / 38,400 bps		
	Effective distance	Up to 800 m		
	Maximum number of connections	31 units (station number: 1 to 127)		
	Response waiting time	5 ~ 99 ms		
	Start bit	1bit (fix)		
	Stop bit	1bit (fix)		
Data bit	8 bit			
Parity bit	None / Odd / Even			

Temperature Controller
Recorder
Digital Counter
Timer
Analog Timer
Panel Meter
Multi Pulse Meter
Proximity Sensor
Photo Sensor
Rotary Encoder
Thyristor Power Regulator
Solid State Relay
Power Supply
Control Switch
Push Button / Main Switch
Cam Switch / Limit Switch
Micro / Hoist Switch
Foot / Mono Lever Switch
Signal Light
Terminal Block / Power Buzzer / Fuse Holder / Control Box

Suffix code

Model	Code	Information
GE--	<input type="checkbox"/> <input type="checkbox"/> <input type="checkbox"/> <input type="checkbox"/> <input type="checkbox"/>	Digital counter
Dimension	3	96 X 48 mm
	4	48 X 48 mm
	6	72 X 36 mm
	7	72 X 72 mm
Type	P	Pre-set counter
	T	Total counter (only for indication)
Displayable digit	4	4 digits (9999) ※ GE3 and GE7 are not selectable
	6	6 digits (999999)
Setting stage	1	1 Stage setting
	2	2 Stage setting
Power supply voltage	A	100 – 240 V a.c. 50 – 60 Hz
	D	24 – 60 V d.c./a.c. 50 – 60 Hz
Model	Code	Information
GE	<input type="checkbox"/> - <input type="checkbox"/> <input type="checkbox"/> <input type="checkbox"/> <input type="checkbox"/> <input type="checkbox"/>	Digital counter & timer
Appearance	3N	96 X 48 mm
	4N	48 X 48 mm
	6N	72 X 36 mm
	7N	72 X 72 mm
Type	P	Preset counter
	T	Total counter (Only for indication)
Displayable digit	4	4 digits (9999)
	6	6 digits (999999)
Setting stage	–	No setting
	1	1 Stage setting
	2	2 Stage setting
Power supply voltage	M	RS485(MODBUS-RTU)
	–	No setting

Digital Counter/Timer

■ LC1 LCD display digital counter

Specification

Model		LC1	LC1-F
Appearance			
Input type		Non-voltage input	Voltage input
Power supply voltage		Lithium battery built in	
Dimension		DIN 48 X 24 mm	
Input action		UP Count	
Computation speed		1/30/100/ 1K cps	20 cps
Input condition		Remaining voltage when breaks : 0.7 V Max impedance when breaks : max 10 k Ω Min impedance when opens : min 1 M Ω	HIGH : 24 – 240 V a.c. / 6 – 240 V d.c. LOW : 0 – 2 V a.c./d.c.
Reset	Input type	Non-voltage input	
	Min signal width	Min 20 ms	
Battery life expectancy		At least 7 years (approx. 25 °C) ※This is calculated value so it is not certified value (Replacing cycle reference value)	
External setting switch		Switch1 : internal power/front reset selectable Switch2 : computing speed selectable (4 kinds)	Switch1 : internal power/front reset selectable
External connection		Terminal (4P)	
Display method		7 segments LCD (character height : 8.7 mm)	
Displayable digits		8 digits	
Insulation resistance		Min 100 M Ω (500 V d.c.), conductive terminal non-recharging metal	
Dielectric strength		2,000 V a.c. 50/60 Hz for 1 min (conductive part-disposable metal)	
Vibration resistance		10 – 55 Hz, double amplitude 0.75 mm, each direction in 3 axis, 2h	
Shock resistance		300 %, each direction in 3 axis each 3 times	
Ambient temperature		–10 ~ 55 °C	
Ambient humidity		35 ~ 85 % RH	
Storage temperature		–20 ~ 65 °C	
Degree of protection		IP66 (Front side)	
Weight		58 g	

Suffix code

Model	Code	Information
LC1	<input type="checkbox"/>	Compact LCD display total counter (dimension : DIN 48 X 24 mm)
Input signal		Non voltage input
	F	Voltage input (24 – 240 V a.c., 6 – 240 V d.c.)

Digital Counter/Timer

LT1 LCD display digital Timer

Specification

Model		LT1	LT1-F
Appearance			
Power supply voltage		Lithium battery built in	
Dimension		DIN 48 X 24 mm	
Operation type		UP Timer	
Time display		9999 h 59 m 59 s / 99999 h 59.9 m / 999999 h 59 m / 9999999.9 h	
Time accuracy		± 0.01 %	
Input condition		Remaining voltage when breaks : 0.7 V Max impedance when breaks : max 10 kΩ Min impedance when opens : min 1 MΩ	HIGH : 24 – 240 V a.c. / 6–240 V d.c. LOW : 0 – 2 V a.c./d.c.
Start	Input type	Non-voltage input	Voltage input
	Min signal width	Min 20 ms	
Reset	Input type	Non-voltage input	
	Min signal width	Min 20 ms	
Battery life expectancy		Expectancy : at least 10 years (approx. 25°C) ※This is calculated value so it is not certified value (Replacing cycle reference value)	
External setting switch		Switch 1 : internal power / front reset selectable Switch 2 : computing speed selectable (4 kinds) time range selectable	
External connection		Terminal (4P)	
Display method		7 segments LCD (character height : 8.7 mm)	
Displayable digits		8 digits	
Insulation resistance		Min 100 MΩ(500 V d.c.), conductive terminal–disposable metal	
Dielectric strength		2000 V a.c. 50/60 Hz for 1 min (conductive part–non–recharging metal)	
Vibration resistance		10 – 55 Hz, double amplitude 0.75 mm, each direction in 3 axis, 2h	
Shock resistance		300 %g, each direction in 3 axis each 3 times	
Ambient temperature		–10 ~ 55 °C	
Ambient humidity		35 ~ 85 % RH	
Storage temperature		–20 ~ 65 °C	
Degree of protection		IP 66 (Front side)	
Weight		58 g	

Suffix code







Model	Code	Information
LT1	<input type="checkbox"/>	Compact LCD display total Timer (dimension : DIN 48 X 24 mm)
Input signal		Non voltage input
	F	Voltage input (24 – 240 V a.c., 6 – 240 V d.c.)

Temperature Controller
Recorder
Digital Counter/Timer
Analog Timer
Panel Meter
Multi Pulse Meter
Proximity Sensor
Photo Sensor
Rotary Encoder
Thyristor Power Regulator
Solid State Relay
Power Supply
Control Switch
Push Button / Main Switch
Cam Switch / Limit Switch
Micro / Hoist Switch
Foot / Mono Lever Switch
Signal Light
Terminal Block / Power Buzzer / Fuse Holder / Control Box

Digital Counter/Timer

GF series Digital counter / Timer

Specification

Model	GF7-P62 / GF7-P42	GF7-P61 / GF7-P41	GF7-T60	GF4-P41	GF4-P40	GF4-P41S
Appearance						
W×H×D(mm)	72 X 72 X 112			48 X 48 X 90.8		48 X 48 X 71.8
Type	Preset		Totalizing	Preset	Totalizing	Preset
Display digits	4 digits or 6 digits		6 digits	4 digits		
Preset stages	Double stage	Single stage	—	Single stage	—	Single stage
Function	Preset counter/Timer(selectble), Prescale setting, Displaying unit decimal point setting, NPN input/PNP input (Selectable by the dip switch)					
Counting speed	30 cps, 1K cps, 3K cps, 5K cps Select by using the volume (Located on the front panel) ※Input signal levels : [High] 5 to 30 V d.c. [Low] 0 to 2 V d.c.			30 cps, 5K cps (Select by using the dip switch) ※Input signal levels : [High] 5 to 30 V d.c. [Low] 0 to 2 V d.c.		
Input action	UP, DOWN, UP/DOWN (Selectable by the dip switch)			—		
Output action	N, F, C, R, K, P, Q, A (Selectable by the dip switch) ※With the totalizing counter, it is displayed as F, K output mode					
Prescale	Applicable only preset counter, 0.001 ~ 9999(4 digits), 0.00001 ~ 999999(6 digits)			Applicable only preset counter, 0.001 ~ 9999(4 digits)		
Timer range	4 digit : 99.99s, 999.9s, 9999s, 99m59s, 999.9m, 99h59m, 999.9h, 9999h 6 digit : 99999.9s, 999999s, 99m59.99s, 999m59.9s, 99999.9m, 99h59m59s, 9999h59m, 99999.9h					
Power supply voltage	100 – 240 V a.c. 50 – 60 Hz (Voltage fluctuation : ±10 % of the power supply voltage)					
External power supply	12 V d.c. 100 mA max					
Control output	Contact : 250 V a.c. 3A (Resistive load), ※(Out 1 / Out 2 : Form C) Solide state : 30 V 100 mA max (Open collector)		—	Contact : 250 V a.c. 3A (Resistive load) Solide state : 30 V 100 mA max (Open collector)		Contact : 250 V a.c. 3A (Resistive load)

Suffix code



Model	Code	Information
GF7-	<input type="checkbox"/> <input type="checkbox"/> <input type="checkbox"/> <input type="checkbox"/>	Digital counter / Timer (72 X 72 mm)
Type	P	Preset counter
	T	Total counter
Displayable digits	4	4 digits (9999)
	6	6 digits (999999)
Setting stage	1	1st stage setting
	2	2nd stage setting
	0	Total counter
Pre-scale function	E	Pre-scale function built in (Preset counter)
	N	No Pre-scale (Total counter)

Model	Code	Information
GF4-	<input type="checkbox"/> <input type="checkbox"/> <input type="checkbox"/> <input type="checkbox"/>	Digital counter / Timer (48 X 48 mm)
Type	P	Preset counter
	T	Total counter
Displayable digits	4	4 digits (9999)
Setting stage	0	None (total counter)
	1	1st stage setting (Preset counter)
Terminal structure	N	Terminal
	S	8 pin structure (suitable for 8 pin socket)

Digital Counter/Timer

■ TT series Digital dual Timer

■ Specification

Model		TT7H	TT4-P42A	TT4-P42B
Appearance				
W×H×D(mm)		72 X 72 X 87	48 X 48 X 100	48 X 48 X 100
Power supply		100 – 240 V a.c., 50 – 60 Hz		
Voltage Regulation		±10 % of Power supply voltage		
Power Consumption		About 9.6 VA (220 V a.c. 60 Hz)	Below 9.1 VA (at 220 V a.c. 60Hz)	
Display method		ON time display : Red color 4 digits (alphabet height 18.7mm) OFF time display : Red color 4 digits (alphabet height 14.5mm)	PV : 11 mm, SV : 8 mm	
External Connection type		Terminal	Plug 11 Pin	Plug 8 Pin
Min. signal amplitude	START	Min. 1s	Min. 20 ms	–
	RST/INH			
Control	Contact	Output : Instantaneous SPDT (1c)	OUT A : Specified time SPDT (1c), OUTB : Specified time SPDT(1c)	
	Construction capacity	NO contact : 250 V a.c. 5 A resistive load, NC contact 250 V a.c. 2 A resistive load		
Life	Mechanical	Min. 10 million		
	Electrical	Min. 100,000 times (250 V a.c. 3 A resistive load)		
Dielectric strength		2,000 V a.c. 50/60Hz for 2 min	2,000 V a.c. 50 / 60 Hz for 1 minute	
Noise Immunity		±2 kV (Between unit's power terminals), square wave by noise simulator (pulse width : 1μs)		
Insulation resistance		Min. 100 MΩ (500 V d.c. mega standard)		
Vibration (Durability)		10 – 55 Hz (cycle for 1min) Peak amplitude 0.75 mm for 1 hour each in X, Y and Z direction		
Shock	Mechanical Durability	300 % 3 times each in X, Y and Z direction		
	Malfunction Resistance	100 % 3 times each in X, Y and Z direction		
Ambient temperature		–10 ~ 55 °C (Without condensation)		
Storage temperature		–20 ~ 65 °C (Without condensation)		
Ambient humidity		30 ~ 85 % RH		

■ Suffix code

Model	Code	Information
TT4	<input type="checkbox"/> <input type="checkbox"/> <input type="checkbox"/> <input type="checkbox"/>	Digital dual timer (48 X 48 mm)
Setting division	P	Exclusive for setting
Displayable digit	4	4 digits (9999)
Setting stage	2	2nd stage setting
External connection	A	11 pins plug type
	B	8 pins plug type

Model	Code	Information
TT7H-	<input type="checkbox"/> <input type="checkbox"/> <input type="checkbox"/> <input type="checkbox"/>	Digital twin timer, 72 (W) × 72 (H) mm
Setting division	P	Preset (Exclusive for setting)
Displayable digit	4	4 digits (9999)
Control output	1	1 level output
External connection	A	9 pin terminal type (external input)

Temperature Controller

Recorder

Digital Counter
Timer

Analog
Timer

Panel
Meter

Multi Pulse
Meter

Proximity
Sensor

Photo
Sensor

Rotary
Encoder

Thyristor
Power
Regulator

Solid
State
Relay

Power
Supply

Control
Switch

Push Button /
Main
Switch

Cam Switch /
Limit
Switch

Micro /
Hoist
Switch

Foot /
Mono Lever
Switch

Signal
Light

Terminal Block /
Power Buzzer /
Fuse Holder /
Control Box

Digital Counter/Timer

TF series Digital Timer

Specification

Model	TF4-A	TF4-B	TF4-C
Appearance			
W×H×D (mm)	48 X 48 X 95.6		
Terminal type	8 pin Plug		
Control method	Up, Down		
Display method	LED Height 7 Segment LED : 8 mm		
Display digit	4 digits		
Time setting range	999.9 sec / 9999 sec	9 m 59.9 sec / 59 m 59 sec	59 hours, 59 minute
Input signal	External reset, inhibit: Min. input signal width 0.02 sec. Power reset: Min. power opening time 0.5 sec.		
Power voltage	100 – 240 V a.c. 50/60 Hz		
Power consumption	Approx. 4.8 VA (220 V a.c. 60 Hz)		
Control output	Contact output : 1c 250 V a.c. 3 A (resistance load) Non-Contact output: 30 V d.c. 100 mA Max.		
Insulation resistance	Min.100 MΩ (At 500 V d.c.) Part of conduction terminal and exposed non-electrified metal part		
Dielectric strength	2,000 V a.c. 50/60 Hz for 1 minute (Between terminal)		
Vibration	Malfunction Resistance	10 – 55 Hz, X-Y-Z each position for 10 minutes	
	Mechanical Durability	10 – 55 Hz, 0.76mm, X-Y-Z each position for 2 hours	
Shock	Malfunction Resistance	100 % 6 positions, each 3 times	
	Mechanical Durability	300 % 6 positions, each 3 times	
Life	Mechanical	Min. 10 million operations (Relay type)	
	Electrical	Min. 100,000 million operation (Relay type)	
Ambient temperature & humidity	0 ~ 50 °C, 30 ~ 85 % RH		

Suffix code

Model	Code	Information
TF4-	<input type="checkbox"/> <input type="checkbox"/> <input type="checkbox"/> <input type="checkbox"/>	Digital timer 48(W) X 48(H)
Time specification	A	999.9sec / 9999sec
	B	9min 59.9sec / 59min 59sec
	C	999.9min / 59hour 59min
Display method	U	Up display
	D	Down display
Power supply voltage	A	100 – 240 V a.c. 50 – 60 Hz
	D	24 – 60 V d.c.
Control output	R	Relay
	T	Open collector

Digital Counter/Timer

LF4N series Digital Timer

Specification

Model	LF4N-A	LF4N-B	LF4N-C	LF4N-D
Appearance				
W×H×D(mm)	48 X 48 X 75.5			
Terminal type	8 pin Plug			11 pin Plug
Control method	Up, Down			
Display method	LCD			
Display digit	3 digits			
Time setting range	0.01 s ~ 9990 h			
Counting input	Reset, start, inhibit			
Input signal	<ul style="list-style-type: none"> • Non voltage input • Impedance in a short circuit : Max. 2 kΩ • Residual voltage in a short circuit : Max. 0.7 V d.c. • Impedance in open : Min. 100 kΩ 			
Power voltage	24 – 240 V a.c./d.c. 50 / 60 Hz			
Power consumption	Approx. 4.4 VA (240 V a.c.), Approx. 1.5 W (240 V d.c.)		Approx. 7.2 VA (240 V a.c.), Approx. 2.2 W (240 V d.c.)	
Control output	Contact output : 1c 250 V a.c. 3A (Resistive load)			
Insulation resistance	Min.100 MΩ (At 500 V d.c.) Part of conduction terminal and exposed non-electrified metal part			
Dielectric strength	2,000 V a.c. 50/60 Hz for 1 minute (Between terminal)			
Vibration	Malfunction Resistance	10 – 55 Hz, X-Y-Z each position for 10 minutes		
	Mechanical Durability	10 – 55 Hz, 0.76mm, X-Y-Z each position for 2 hours		
Shock	Malfunction Resistance	100 % 6 positions, each 3 times		
	Mechanical Durability	300 % 6 positions, each 3 times		
Life	Mechanical	Min. 10 million operations (Relay type)		
	Electrical	Min. 100,000 million operation (Relay type)		
Ambient temperature & humidity	0 ~ 50 °C 30 ~ 85 %RH			

Suffix code

Model	Code	Information		
LF4N-	<input type="checkbox"/>	Digital timer 48(W) X 48(H) mm		
Device selection	A	Time limit : 1c	Operation mode (10 kinds)	8pin socket type
	B	Time limit : 1c, Constantaneous : 1c	ON Delay output (A mode fixed)	
	C	Time limit : 2c		Operation mode (10 kinds)
	D	Time limit : 1c	11pin socket type	
Power supply voltage		24 – 240 V a.c./d.c. dual usage 50 – 60 Hz		

Temperature Controller



Recorder

Digital Counter
TimerAnalog
TimerPanel
MeterMulti Pulse
MeterProximity
SensorPhoto
SensorRotary
EncoderThyristor
Power
RegulatorSolid
State
RelayPower
SupplyControl
SwitchPush Button /
Main
SwitchCam Switch /
Limit
SwitchMicro /
Hoist
SwitchFoot /
Mono Lever
SwitchSignal
LightTerminal Block /
Power Buzzer /
Fuse Holder /
Control Box

Digital Counter/Timer

LY series LCD weekly yearly timer switch

Specification

Model		LY4	LY7
Appearance			
W×H×D(mm)		DIN 48 X 48 mm	DIN 72 X 72 mm
Power supply voltage		100 – 240 V a.c. 50/60 Hz (Dual usage)	
Allowable voltage variation		±10 % of the power supply voltage	
Power consumption		Approx 2.6 VA (220 V a.c. 60 Hz)	Approx 4.2 VA (220 V a.c. 60 Hz)
Display method		LCD display method (displayable digit : 4 digits, 2 lines) 1st display: character height 7.8 mm, 2nd display : character height 5.2 mm	LCD display method (displayable digit : 4 digits, 2 lines) 1st display : character height 12 mm, 2nd display : character height 7 mm
1 cycle time		Weekly setting : for 1 week (7days), Yearly setting : for 1 year (calendar until 2099)	
Backup time		More than 5 consecutive years (25 °C)	
setting steps	Number of program setting	Weekly program : 64 step, yearly program : 32 step	
	Number of season setting	4 seasons (Spring, summer, fall, winter)	
	Number of holidays in one year	16 times	
Installation type (external connection)		Flush panel mount type, and exposed panel mount type(dual usage) (Din rail installation and screw fixing)	
Cycle error		±15 sec/mon (25 °C)	
Time error		Less than ±0.01% ±0.05 sec (Setting error, Power error, Temperature error)	
Control output	Contact composition	OUT : SPST (1a)	2 independent circuits, OUT1 : SPDT (1c), OUT2 : SPDT (1c)
	Contact capacity	15A 250 V a.c. (resistive load)	
	Life Expectancy(mechanically)	Above 10 million times	
	Life Expectancy(electrically)	Above 50 thousand times (250 V a.c. 15 A resistive load)	
Insulation resistance		100 MΩ min (500 V d.c. mega standard, actuator terminal and exposed non-charged metal part)	
Dielectric strength		2000 V a.c. 50/60 Hz for 1 min (actuator terminal and exposed non-charged metal part)	
Noise immunity		±2 kV (between the actuating power terminal), square wave shape noise by the noise simulator (Pulse width = 1 us).	
Vibration	Mechanical Durability	10 – 55 Hz (for cycle 1 min) 0.75 mm double amplitude for 1 hrs each in X, Y and Z	
	Malfunction Resistance	10 – 55 Hz (for cycle 1 min) 0.5 mm double amplitude for 10 minutes each in X, Y and Z	
Storage	Mechanical Durability	300 % 3 times each in X, Y and Z directions	
	Malfunction Resistance	100 % 3 times each in X, Y and Z directions	
Ambient temperature		-10 ~ 55 °C (with no icing)	
Storage temperature		-20 ~ 65 °C (with no icing)	
Ambient humidity		35 ~ 85 % RH	
Weight		Approx. 100 g (excluded the weight of box)	Approx. 275 g (excluded the weight of box)

Suffix code

Model	Code	Information
LY-	<input type="checkbox"/>	LCD weekly, Yearly time switch
Dimension	4	DIN 48 × 48 mm
	7	DIN 72 × 72 mm
Power supply voltage	100 – 240 V a.c. 50/60 Hz (Dual usage)	

T21 Timing Relay

Specification

Model	AC	T21 - 1 / 3 / 6 / 3H - 4A20
	DC	T21 - 1 / 3 / 6 / 3H - 4D24
Appearance		
Power supply voltage	AC	200 - 230 V a.c. 50/60 Hz
	DC	24 V d.c.
Operating voltage range		Power supply voltage $\pm 10\%$
Power Consumption	AC	3.1 VA max (230 V a.c. 60 Hz)
	DC	1.5 W max (24 V d.c.)
Reset time		100 ms max
Time Range	1	0.1 sec ~ 10 min
	3	0.3 sec ~ 30 min
	6	0.6 sec ~ 60 min
	3H	0.3 hrs ~ 24 hrs
Accuracy of operating time		$\pm 1\%$ FS max
Setting Error		$\pm 10\%$ FS max
Control output	Output mode	Power on delay, Interval, Flicker OFF Start, Flicker ON Start
	Contact construction	4a4b
	Capacity	250 V a.c. 3A Resistive load
Life expectancy		Mechanical : 10 million operations min, Electrical : 200,000 operations min
Insulation resistance		100 M Ω min (at 500 V d.c., Between current-carrying terminals and exposed noncurrent-carrying metal parts.)
Dielectric strength		2000 V a.c. 50/60 Hz 1 minute (Between current-carrying terminals and exposed noncurrent-carrying metal parts.)
Noise immunity		± 2 kV (Between power terminal, pulse width ± 1 μ s, square wave noise by noise simulator)
Vibration resistance		10 - 55 Hz (For 1 min), Double amplitude 0.75mm X, Y, Z each direction for 1 hour
Shock resistance		300 % X, Y, Z each direction for 3 times
Ambient temperature		-10 ~ 50 °C (Without condensation)
Storage temperature		-25 ~ 65 °C (Without condensation)
Ambient humidity		35 ~ 85 % RH
Weight		Approx. 42 g



Suffix code

Model	Code	Information
T21-	<input type="checkbox"/> <input type="checkbox"/> <input type="checkbox"/>	Timing Relay
Time Range	1	1 sec, 10 sec, 1 min, 10 min
	3	3 sec, 30 sec, 3 min, 30 min
	6	6 sec, 60 sec, 6 min, 60 min
	3H	3 hrs, 6 hrs, 12 hrs, 24 hrs
Contact	4	4a4b
Power supply voltage	A20	200 - 230 V a.c.
	D24	24 V d.c.

Analog Timer

T38N, T48N, T57N Power On Delay Timer

Specification

Model	Exposure type	T38N	T48N	T57NE
	Panel type			T57NP
Appearance	CE			
	W×H×D (mm)	40.5 X 50.5 X 74	48 X 48 X 78.7	50.0 X 62.0 X 86.2 57.5 X 84.4 X 83.7
Function	POWER ON DELAY TIMER			
Power supply	24 – 240 V a.c. 50/60 Hz, 24 – 240 V d.c.			
Allowable voltage variation	±10 % of Power supply Voltage			
Power consumption	Less than 4.5 VA (at 240 V a.c. 60 Hz), Less than 1.5 W (at 24 V d.c.)			
Return time	Less than 100 ms			
maximum time	01	0.01 ~ 1 s / 0.01 ~ 1 m / 0.01 ~ 1 h		
	03	0.01 ~ 3 s / 0.01 ~ 3 m / 0.01 ~ 3 h		
	06	0.01 ~ 6 s / 0.01 ~ 6 m / 0.01 ~ 6 h		
	10	0.01 ~ 10 s / 0.01 ~ 10 m / 0.01 ~ 10 h		
	30	0.01 ~ 30 s / 0.01 ~ 30 m / 0.01 ~ 30 h		
	60	0.01 ~ 60 s / 0.01 ~ 60 m / 0.01 ~ 60 h		
	12H	0.01 ~ 12 h / 0.01 ~ 24 h / 0.01 ~ 48 h ('24h' and '48h' time setting '12h' : 'x2' and 'x4')		
Time error	Repeat error	Less than ±0.3 % (ratio against Max. scale)		
	Setting error	Less than ±5 % (ratio against Max. scale)		
Control output	Output mode	POWER ON DELAY		
	Contact	A type (Time – limit 1c + Instantaneous 1a) / B type (Time – limit 1c + Instantaneous 1c) / C type (Time – limit 2c)		
	Contact capacity	250 V a.c. 3 A (Resistive load)		
Life span of relay	Mechanical : More than 10 million times / Electrical : More than 100,000 times			
Dielectric strength	2,000 V a.c. 50/60 Hz for 1 minute			
Noise Immunity	±2 kV (Between unit's power terminals), square wave by noise simulator (pulse width : 1 μs)			
Insulation resistance	More than 100 MΩ (Based on 500 V d.c. mega standard)			
Vibration (Durability)	10 – 55 Hz (cycle :1 minute), Double amplitude 0.5 mm X:Y:Z each direction for 2h.			
Shock (Durability)	300 % (30 G) X:Y:Z each direction 3 times			
Ambient temperature	–10 ~ 55 °C Without condensation			
Storage temperature	–25 ~ 65 °C Without condensation			
Ambient humidity	30 ~ 85 % RH			



Suffix code

Model	Code	Information
Dimension	<input type="checkbox"/> – <input type="checkbox"/> <input type="checkbox"/> <input type="checkbox"/>	Analog timer
	T38N	T38N timer (40 X 50 mm)
	T48N	T48N timer (48 X 48 mm)
	T57N	T57N timer (58 X 84 mm)
Installation type	P	Panel type (T38N panel adapter sold separately)
	E	Exposure type (Select with T48N panel type)
Range (Dip switch selection)	01	1 sec, 1 min, 1 hour
	03	3 sec, 3 min, 3 hour
	06	6 sec, 6 min, 6 hour
	10	10 sec, 10 min, 10 hour
	30	30 sec, 30 min, 30 hour
	60	60 sec, 60 min, 60 hour
	12	12 hour, 24 hour, 48 hour
Control output	A	Time limit : 1c contact, Constantaneous : 1a contact
	B	Time limit : 1c contact, moment : 1c contact
	C	Time limit : 2 x 1c
	D	TF62N twin timer fixing code
	F	TF62D dual timer fixing code
Power supply voltage	24 – 240 V a.c. / d.c. 50 – 60 Hz (dual usage)	

※ Installation type selection is only applied to the model T57N, TF62N and TF62D (Model T38N requires separate purchase of panel adapter)

TF62N, TF62D Twin / Dual Timer

Specification

Model	Exposure type	TF62NE	TF62DE
	Panel type	TF62NP	TF62DP
Appearance			
W×H×D (mm)	50.0 X 62.0 X 91.2 57.5 X 84.5 X 83.7		50.0 X 62.0 X 91.2 57.5 X 84.5 X 83.7
Function	TWIN TIMER		DUAL TIMER
Power supply	24 – 240 V a.c. 50/60 Hz, 24 – 240 V d.c.		
Allowable voltage variation	±10 % of Power supply Voltage		
Power consumption	Less than 4.5 VA (at 240 V a.c. 60 Hz), Less than 1.5 W (at 24 V d.c.)		
Return time	Less than 100 ms		
maximum time	01	0.01 ~ 1 s / 0.01 ~ 1 m / 0.01 ~ 1 h	
	03	0.01 ~ 3 s / 0.01 ~ 3 m / 0.01 ~ 3 h	
	06	0.01 ~ 6 s / 0.01 ~ 6 m / 0.01 ~ 6 h	
	10	0.01 ~ 10 s / 0.01 ~ 10 m / 0.01 ~ 10 h	
	30	0.01 ~ 30 s / 0.01 ~ 30 m / 0.01 ~ 30 h	
	60	0.01 ~ 60 s / 0.01 ~ 60 m / 0.01 ~ 60 h	
	12H	'12' model is not available	
Time error	Repeat error	Less than ±0.3 % (ratio against Max. scale)	
	Setting error	Less than ±5 % (ratio against Max. scale)	
Control output	Output mode	FLICKER (ON Start)	FLICKER (ON=A Start)
	Contact	D type (Time – limit 1c)	F type (Time – limit 2c)
	Contact capacity	250 V a.c. 3 A (Resistive load)	
Life span of relay	Mechanical : More than 10 million times / Electrical : More than 100,000 times		
Dielectric strength	2,000 V a.c. 50/60 Hz for 1 minute		
Noise Immunity	±2 kV (Between unit's power terminals), square wave by noise simulator (pulse width : 1 μs)		
Insulation resistance	More than 100 MΩ (Based on 500 V d.c. mega standard)		
Vibration (Durability)	10 – 55 Hz (cycle :1 minute), Double amplitude 0.5 mm X·Y·Z each direction for 2h.		
Shock (Durability)	300 ٪ (30 G) X·Y·Z each direction 3 times		
Ambient temperature	–10 ~ 55 °C Without condensation		
Storage temperature	–25 ~ 65 °C Without condensation		
Ambient humidity	30 ~ 85 % RH		

Suffix code

Model	Code	Information
Dimension	<input type="checkbox"/> <input type="checkbox"/> <input type="checkbox"/> <input type="checkbox"/>	Analog timer
	TF62N	TF62N twin timer (58 X 84 mm)
	TF62D	TF62D dual timer (58 X 84 mm)
Installation type	P	Panel type (T38N panel adapter sold separately)
	E	Exposure type (Select with T48N panel type)
Range (Dip switch selection)	01	1 sec, 1 min, 1 hour
	03	3 sec, 3 min, 3 hour
	06	6 sec, 6 min, 6 hour
	10	10 sec, 10 min, 10 hour
	30	30 sec, 30 min, 30 hour
	60	60 sec, 60 min, 60 hour
	12	12 hour, 24 hour, 48 hour (※ But exclude the model TF62N and TF62D)
Control output	A	Time limit : 1c contact, Constantaneous : 1a contact
	B	Time limit : 1c contact, moment : 1c contact
	C	Time limit : 2 x 1c
	D	TF62N twin timer fixing code
	F	TF62D dual timer fixing code
Power supply voltage	24 – 240 V a.c. / d.c. 50 – 60 Hz (dual usage)	

※ Installation type selection is only applied to the model T57N, TF62N and TF62D (Model T38N requires separate purchase of panel adapter)

Analog Timer

MA4N series Analog multi timer

Specification

MODEL		MA4N-A	MA4N-B	MA4N-C
Appearance				
W X H X D (mm)		48 X 48 X 94		
Device selection		2c (time limit) ※ 11 pin type	2c (time limit+ constantaneous) ※ 11pin type.	2c (time limit), 2c (time limit+ constantaneous) ※ processed by mode selection (8pin type)
Function		Multi operation, Multi time		POWER ON DELAY, Multi time
Power voltage		24 – 240 V a.c./d.c. 50 – 60 Hz (Dual usage)		
Operating voltage		±10 % of power voltage		
Power consumption		AC : Approx. 5.3 VA Max. DC : 2.5 W		
Time setting range		0.12 sec ~ 300 hours		
Min. signal amplitude		START input, INHIBIT input, RESET input: Min. 20 ms		–
Input		<ul style="list-style-type: none"> Non voltage Input Impedance in a short circuit: Max. 2 kΩ Residual voltage in a short circuit: Max. 0.7 V d.c. Impedance in open: Min. 100 kΩ 		–
Control output	Contact	Specified time DPDT (2c)		Specified time SPDT (1c), Instantaneous time SPDT (1c)
	Contact capacity	250 V a.c. 5 A (Resistive load)		
Variation of operation time		Max. ±0.3 % (Rate against full scale)		
Setting error		Max. ±0.5 %		
Voltage error		Max. ± 5 % ±0.05 sec		
Temperature error		Max. ±2 %		
Dielectric strength		2,000 V a.c. 50/60 Hz for 1minute		
Vibration	Malfuction Resistance	10 – 55 Hz double amplitude 0.75 mm		
	Mechanical Durability	10 – 55 Hz double amplitude 0.5 mm		
Shock	Malfuction Resistance	100 %		
	Mechanical Durability	300 %		
Life	Mechanical	Over 10 million operations (Open & Short frequency : 180 / min)		
	Electrical	Over 100,000 (250 V a.c. 3 A load resistance)		
Ambient temperature & humidity		0 ~ 50 °C / 30 ~ 85 % RH		

MA4SD series Star-Delta timer

Specification

MODEL		MA4SD	MA4SDI
Appearance			
W X H X D (mm)		48 X 48 X 94	
Power supply voltage		100 – 240 V a.c. 50/60 Hz, 24 - 240 V d.c.	
Allowable voltage		Power supply voltage ±10 %	
Power consumption		Approx. 3.8 VA (100 – 240 V a.c. 60 Hz), Approx. 1.9 W (24 - 240 V d.c.)	
Resetting time		100 ms max	
Operating time range		1 ~ 300 sec	
λ Operating time difference		Repeated error : ±0.3 % max, Setting error : ±5 % max, Voltage error : ±0.5 % max, Temperature tolerance : ±2 % max (Percentage of full scale)	
Δ Conversion time error		±25 % max	
Control output	Output mode	Power ON Start	
	Contact composition	λ Contact : 1 a, ΔContact : 1 a	λ Contact : 1a, ΔContact : 1 a, Instantaneous contact : 1 a
	Contact capacity	250 V a.c. 5 A resistive load	
Relay Life span		Mechanical : 5 million times min, Electrical : 100 thousand times min (250 V a.c. 5 A resistive load)	
Insulation resistance		100 MΩ min (at 500 V d.c. Between current-carrying terminals and exposed noncurrent-carrying metal parts.)	
Dielectric strength		2,000 V a.c. 50/60 Hz 2 minute (Between current-carrying terminal and exposed noncurrent-carrying metal parts.)	
Noise immunity		±2 kV (Between power terminal, pulse width ±1 μs, square wave noise by noise simulator)	
Vibration resistance		10 – 55 Hz (For 1 min), Double amplitude 0.75 mm, X, Y, Z each direction for 1 hour	
Shock resistance		300 % (30G) X, Y, Z each direction for 3 times	
Ambient temperature		-10 ~ 55 °C (icing or dew condensation not allowed)	
Storage temperature		-25 ~ 65 °C (icing or dew condensation not allowed)	
Ambient humidity		35 ~ 85 % RH	
Weight		Approx. 95g (Including fixing bracket)	

Multi Pulse Meter

BP series Multi pulse meter

Specification

Model	BP6	
Appearance		
W X H X D (mm)	72 X 36 X 100	
Function	Auto Zero time setting function, Time unit selection function (Individual input for each bank/ batch input selection function), Parameter lock function, Electricity failure compensation function (applicable only to F9), Remote/local conversion function (applicable only to communication output type), Comparative output function (HH, H, GO, L, LL), 4 steps bank setting function, Current output range selection function, Max, Min, Peak value 10 steps memory function (Max: 4 steps save, average value save, Min: 4 steps save, average save), Start compensation timer function, Display cycle setting function	
Power Supply	100 – 240 V a.c. 50 – 60 Hz 24 – 60 V d.c./a.c. 50 – 60 Hz	
Power Consumption	Below 10 VA (240 V a.c.) Below 6 W (24 V d.c.)	
Voltage output for Sensor	12 V d.c. $\pm 10\%$ 120 mA (voltage fluctuation rate: $\pm 10\%$)	
Measuring Accuracy	FS $\pm 0.01\%$ rdg ± 1 dig	
Measurement Range	0.0005 Hz \sim 50 kHz, 0.001 s \sim 3,200 s, 0 \sim 4 x 10 Count	
Max. Display Digits	5 digits (-19999 \sim 99999)	
Display method	7 Segment	
Input Signal	Non-Contact Input: Max. 50 kHz (ON/OFF width for each above 10 μ s) (ON voltage: 4.5 V – 24 V, OFF voltage: 0 – 1.0 V) Contact Input: Max. 30 Hz (ON/OFF width for each above 33 ms) (12 V d.c., able to switch the current of 2 mA sufficiently)	
Output type	Relay Output (H, GO, L)	
Operation Mode	·F1: revolution/ frequency/ speed ·F2: moving speed ·F3: cycle ·F4: passing time ·F5: time difference ·F6: time width ·F7: pulse width ·F8: pulse interval ·F9: Addition count ·F10: absolute ratio ·F11: error ratio ·F12: density ·F13: error	
Noise Immunity	By noise simulator, square-shaped wave noise (pulse width 1 μ s) ± 2000 V	
Vibration	Mechanical Durability	10 – 55 Hz double amplitude width 0.75 mm in each X:Y:Z direction for 2 hours
	Malfunction Resistance	10 – 55 Hz double amplitude width 0.5 mm in each X:Y:Z direction for 10 minutes
Shock	Mechanical Durability	300 % (approx. 30G) in each X:Y:Z direction for 3 times
	Malfunction Resistance	100 % (approx. 10G) in each X:Y:Z direction for 3 times
Operating Ambient Environment	Temperature: -10 \sim 50 $^{\circ}$ C (without condensation) Humidity: 35 \sim 85 % R.H.	





Suffix code

Model	Code	Information
BP	<input type="checkbox"/> <input type="checkbox"/> <input type="checkbox"/> <input type="checkbox"/>	Multi pulse meter
Dimension	6	72(W) X 36(H) mm
Displayable digit	5	5 digits (-19999 – 99999)
Power supply voltage	A	100 – 240 V a.c. 50 – 60 Hz
	D	24 – 60 V d.c. / a.c.
Output specification		Main output
	N	Display only
	1	Relay 3 stages output

Multi Pulse Meter

RP series Multi pulse meter

Specification

Model	RP7	RP3	RP4	RP6	RP1
Appearance					
W X H X D (mm)	72 X 72 X 92	96 X 48 X 105	48 X 48 X 85	72 X 36 X 105	48 X 24 X 100
Function	·Auto Zero time setting function ·Time unit selection function ·Parameter lock function ·Electricity failure compensation function(applicable only to F9) ·Remote/local conversion function (applicable only to communication output type) ·Comparative output function (HH, H, GO, L, LL) ·Current output range selection function ·Max, Min, Peak value 10 steps memory function (Max : 4 steps save, average value save, Min: 4 steps save, average save) ·Starting compensation timer function ·Display cycle setting function				
Power Supply	100 – 240 V a.c. 50 – 60 Hz				
Power Consumption	Below 9.5 VA (240 V a.c.)	Below 9.5 VA (240 V a.c.)	Below 6 W (24 V d.c.)	Below 5 W (24 V d.c.)	Below 10 VA (240 V a.c.)
Voltage output for Sensor	12 V d.c. ±10 % 120 mA (voltage fluctuation rate ±10 %)				
Measuring Accuracy	± 0.02 % rdg ±1 digit				
Measurement Range	0.0003 ~ 10 kHz, 0.001 s ~ 3,200 s, 0 ~ 4 x 10 ⁹ Count				
Max. Display Digits	5 Digits (0 ~ 99999)				4 digit (0 ~ 9999)
Display Method	7 Segment				
Input Signal	Non-Contact Input: Max. 10 kHz (ON/OFF width for each above 50 μs)(ON voltage: 4.5 – 24 V, OFF voltage : 0 – 1.0 V) Contact Input: Max. 30 Hz (ON/OFF width for each above 33 ms)(12 V d.c., able to switch the current of 2 mA sufficiently)				
Output type	Relay Output (H, GO, L) (HH, H, GO, L, LL)	Relay Output (H, GO, L) (HH, H, GO, L, LL)	Relay Output (H)	Relay Output (H, GO, L)	Relay Output (H)
Operation Mode	·F1: Revolution/ Frequency/ Speed ·F2: Moving speed ·F3: Cycle ·F4: Passing Time ·F5: Time Difference ·F6: Time Width ·F7: Pulse Width ·F8: Pulse Interval ·F9: Addition Counter				
Noise Immunity	By noise simulator, square-shaped wave noise (pulse width 1μs) ±2000 V				
Vibration	Mechanical Durability	10 – 55 Hz double amplitude width 0.75 mm in each X-Y-Z direction for 2 hours			
	Malfunction Resistance	10 – 55 Hz double amplitude width 0.5 mm in each X-Y-Z direction for 10 minutes			
Shock	Mechanical Durability	300 % (approx. 30G) in each X-Y-Z direction for 3 times			
	Malfunction Resistance	100 % (approx. 10G) in each X-Y-Z direction for 3 times			
Operating Ambient Environment	Temperature: -10 ~ 50 °C (without condensation) Humidity: 35 ~ 85 % RH				

Suffix code

Model	Code	Information	
RP	<input type="checkbox"/> <input type="checkbox"/> <input type="checkbox"/> <input type="checkbox"/>	Multi Pulse Meter	
Dimension	1	48 (W) × 24 (H)	
	3	96 (W) × 48 (H)	
	4	48 (W) × 48 (H)	
	6	72 (W) × 36 (H)	
	7	72 (W) × 72 (H)	
Displayable digit	4	4 digits 1 stage (0 – 9999) ※ applicable to RP1	
	5	5 digits 1 stage (0 – 99999)	
Power specification	A	100 – 240 V a.c. 50 – 60 Hz	
	D	24 – 60 V d.c. / a.c. ※ Exception : RP1	
Output specification	RP1	H	Display Only
		1	Relay 1 stage output (H : High limit output)
	RP3	N	Display Only
		1	Relay 3 stages output (H, GO, L)
		2	Relay 5 stages output (HH, H, GO, L, LL)
	RP4	4	NPN Open Collector 5 stages output, 4 – 20 mA d.c.(Retransmission output)
		N	Display Only
	RP6	1	Relay 1 stage output (H : High limit output)
		N	Display Only
	RP7	1	Relay 3 stages output (H, GO, L)
		3	NPN Open Collector 5 stages output, 4 – 20 mA d.c.(Retransmission output)
		N	Display Only
		1	Relay 3 stages output (H, GO, L)
2		Relay 5 stages output (HH, H, GO, L, LL)	
5	NPN Open Collector 5 stages output, 4 – 20 mA d.c.(Retransmission output)		

WM3 Digital wattmeter

Specification

Model	WM3
Appearance	
WXHxD(mm)	96 X 48 X 100
Measurement method	Period measuring type
Input voltage	0 – 220 V a.c.
Displaying period	0.1 ~ 2 sec
Power factor	80 ~ 100 %
Response speed	Approx. 2 sec (max range)
max displayable digit	4 digits (-1999 ~ 9999)
Displaying part	7 segments LED
Accuracy	Less than ± 5 Digit
Insulation resistance	Min 100 MΩ(500 V d.c.)
Dielectric strength	1500 V a.c. for 1 min (power terminal – input terminal)
Communication output(RS485)	Able to set the address from 00 ~ 99 and able to select the baud rate of series transfer. (Transfer speed : 1200, 2400, 4800, 9600, 19200 bps)
Current output (transfer)	Yields the 4 – 20 mA d.c. output corresponding to the current indication value. (Resolving power: 12,000)
Transistor output	PNP/NPN open collector output (12 – 24 V d.c. 50 mA max)
Relay output	1 a X 3 contact (HI, GO, LO), (220 V a.c. 5 A)
Power supply voltage	100 – 240 V a.c. 50 – 60 Hz (Dual usage)
Voltage fluctuation	-15 ~ 10 % of the power supply voltage
Power consumption	Approx. 5 VA
Weight	300 g
Ambient temperature	0 ~ 50 °C
Ambient humidity	35 ~ 85 % RH
Storage temperature	-10 ~ 70 °C
Vibration resistance	10 – 55 Hz single amplitude, to the each direction of X, Y, Z for 2 hour
Shock resistance	300 m/s ² , to the 6 direction of X, Y, Z and each 3 times

Suffix code

Model	Code	Information
WM3-	<input type="checkbox"/> <input type="checkbox"/> <input type="checkbox"/>	Digital wattmeter (DIN 96 X 48 mm)
Phase and wire	1	Single phase 2 wire type (0 – 220 V a.c.)
Input specification	01	Refer to the input specification (Refer to the code)
Output (Optional)	N	Only for displaying
	0	Relay (HI, GO, LO), 4 – 20 mA d.c.
	1	Relay (HI, GO, LO)
	2	NPN Open collector (HI, GO, LO), 4 – 20 mA d.c.
	3	PNP Open collector (HI, GO, LO), 4 – 20 mA d.c.
	4	NPN Open collector (HI, GO, LO), RS485
	5	PNP Open collector (HI, GO, LO), RS485

Panel Meter

MP3 series Digital multimeter

Specification

Model	MP3
Appearance	 <p>(Front Plate Type) (Front Acrylic Type)</p>
W×H×D (mm)	96 X 48 X 112
Power Supply	100 – 240 V a.c. 50 – 60 Hz voltage fluctuation rate ±10 %
Power Consumption	5 VA
Display	7 Segment LED Display
Insulation Resistance	100 MΩ minimum (at 500 V d.c.) between external terminal and case
Dielectric Strength	2000 V a.c. minimum for 1 minute between external terminal and case
Noise Immunity	By noise simulator, square-shaped wave noise, pulse width 1μs, ±3000 V
Vibration Resistance	Malfunction Resistance : 10 – 55 Hz Single amplitude 0.5 mm X·Y·Z each direction for 1 hour Mechanical Durability : 10 – 55 Hz Single amplitude 0.75 mm X·Y·Z each direction for 2 hours
Shock Resistance	Malfunction Resistance : 100 % for 3 times each in X·Y·Z direction, Mechanical Durability: 300 % for 3 times each in X·Y·Z direction
Operating Ambient temperature	-10 ~ 55 °C (without condensation)
Operating Ambient Humidity	35 ~ 85 % RH
Operating Circumstance	With no corrosive gas
Storage Ambient Temperature	-20 ~ 65 °C (without condensation)
Relay Life Expectancy	Mechanical: More than 20,000,000 times, Electrical: More than 100,000 times

Suffix code

Model	Code	Information
MP3-	<input type="checkbox"/> <input type="checkbox"/> <input type="checkbox"/> <input type="checkbox"/>	Digital Multi Panelmeter 96 x 48 mm
Displaying digit	4	4 digits (9999)
Input type	DV	DC VOLTAGE
	DA	DC AMPERE
	AV	AC VOLTAGE
	AA	AC AMPERE
	AVR	AC VOLTAGE (RMS) ※Option output can be ordered only N type
	AAR	AC AMPERE (RMS) ※Option output can be ordered only N type
Output (Optional)	N	Display only
	0	Relay Output (HI,GO,LO) + Current Output (4 – 20 mA)
	1	Relay Output (HI, GO, LO)
	2	NPN Open Collector Output (HI,GO,LO) + BCD Output (Dynamic)
	3	PNP Open Collector Output (HI,GO,LO) + BCD Output (Dynamic)
	4	NPN Open Collector Output (HI,GO,LO) + Current Output (4 – 20 mA)
	5	PNP Open Collector Output (HI,GO,LO) + Current Output (4 – 20 mA)
	6	NPN Open Collector Output (HI,GO,LO) + Serial Output (lowspeed)
	7	PNP Open Collector Output (HI,GO,LO) + Serial Output (lowspeed)
	8	NPN Open Collector Output (HI,GO,LO) + RS485 Output
	9	PNP Open Collector Output (HI,GO,LO) + RS485 Output
	10	BCD Output (Static)
11	Relay Output (HI,GO,LO) + RS485 Output	
Front panel type	A	Front Acrylic type (100 – 240 V a.c.)
	B	Front Plate type (100 – 240 V a.c.)
	C	Front Plate type (24 V d.c.) ※Only N type is available

MP6 series Digital multimeter

Specification

Model	MP6
Appearance	 <p>CE</p> <p>〈Front Plate Type〉 〈Front Acrylic Type〉</p>
W×H×D (mm)	72 X 36 X 100
Power Supply	100 – 240 V a.c. 50 – 60 Hz voltage fluctuation rate ±10 %
Power Consumption	Approx. 4 VA
Display	7 Segment LED Display
Insulation Resistance	100 MΩ minimum (at 500 V d.c.) between external terminal and case
Dielectric Strength	2000 V a.c. minimum for 1 minute between external terminal and case
Noise Immunity	By noise simulator, square-shaped wave noise, pulse width 1μs, ±3000 V
Vibration Resistance	Malfunction Resistance : 10 – 55 Hz Single amplitude 0.5 mm X·Y·Z each direction for 1 hour Mechanical Durability : 10 – 55 Hz Single amplitude 0.75 mm X·Y·Z each direction for 2 hours
Shock Resistance	Malfunction Resistance : 100 % for 3 times each in X·Y·Z direction, Mechanical Durability: 300 % for 3 times each in X·Y·Z direction
Operating Ambient temperature	–10 ~ 55 °C (without condensation)
Operating Ambient Humidity	35 ~ 85 % RH
Operating Circumstance	With no corrosive gas
Storage Ambient Temperature	–20 ~ 65 °C (without condensation)
Relay Life Expectancy	Mechanical: More than 20,000,000 times, Electrical: More than 100,000 times



Suffix code

Model	Code	Information
MP6-	<input type="checkbox"/> <input type="checkbox"/> <input type="checkbox"/> <input type="checkbox"/> <input type="checkbox"/>	Digital Multi Panelmeter 72 x 36 mm
Displaying digit	4	4 digits (9999)
Input type	DV	DC VOLTAGE
	DA	DC AMPERE
	AV	AC VOLTAGE
	AA	AC AMPERE
	AVR	AC VOLTAGE (RMS) ※Option output can be ordered only N type
	AAR	AC AMPERE (RMS) ※Option output can be ordered only N type
Output (Optional)	N	Display only
	0	Relay, Current output (4 – 20 mA d.c.)
	1	Relay
	4	NPN Open Collector , Current output (4 – 20 mA)
	5	PNP Open Collector , Current output (4 – 20 mA)
Front panel type	A	Front Acrylic type (100 – 240 V a.c.)
	B	Front Plate type (100 – 240 V a.c.)
	C	Front Plate type (24 V d.c.)

Panel Meter

■ MP3-4H, MP6-4H Digital frequency meter

■ Specification



Model	MP3-4H	MP6-4H
Appearance		
W X H X D (mm)	96 X 48 X 100	72 X 36 X 100
Input signal	AC (voltage, current), DC (voltage, current)	
A/D converting method	Double integral method	
Sampling time	AC type : 300 ms	
Response speed	Approx. 2sec (max range)	
Max displayable digit	4 digits (-1999~9999)	
Displaying unit	7 segments LED	
Accuracy	AC : below ± 5 Digit, DC : below ± 2 Digit	
Insulation resistance	Min 100 M Ω (500 V d.c.)	
Dielectric strength	1500 V a.c. for 1 min (power terminal - input terminal)	
Communication output (RS485)	It can set address from 00 to 99 and it can select modulation rate of direct retransmission, (Retransmission speed : 1200, 2400, 4800, 9600, 19200 bps)	
Current output (Retransmission)	Yields 4~20mA d.c. output regarding current indicated value. (Resolving power : 12,000)	
Transistor output	PNP/NPN open collector output (12 - 24 V d.c. 50 mA max)	
Relay output	1 a X 3 contacts (HI, GO, LO), (220 V a.c. 5 A)	
Power supply voltage	100 - 240 V a.c., 50 - 60 Hz (dual usage)	
Allowable voltage fluctuation range	85 - 264 V a.c.	
Power consumption	Approx. 5 VA	Approx. 5 VA
Weight(g)	Approx. 180	
Ambient temperature	0 ~ 50 °C	
Ambient humidity	35 ~ 85 % RH	
Storage temperature	-10 ~ 70 °C	
Vibration resistance	10 - 55 Hz single amplitude X, Y, Z each direction for 2 hours	
Shock resistance	300 m/s ² , X, Y, Z 6 directions each 3 times	

■ Suffix code

Model	Code	Information
MP	<input type="checkbox"/> <input type="checkbox"/> <input type="checkbox"/> <input type="checkbox"/>	Digital frequency meter
Dimension	3	Dimension 96×48 mm
	6	Dimension 72×36 mm
Displayable digit	4	4 digits (9999)
Output (Optional)	N	Only for display
	0	Relay output (HI, GO, LO) + current output (4 - 20 mA)
	1	Relay output (HI, GO, LO)
	2	NPN TR output (HI, GO, LO) + current output (4 - 20 mA)
	3	PNP TR output (HI, GO, LO) + current output (4 - 20 mA)
	4	NPN TR output (HI, GO, LO) + RS485output
Output (Optional)	5	PNP TR output (HI, GO, LO) + RS485output
	H	AC input frequency measurement

■ BS series Exclusive digital voltmeter-Ammeter

Specification

Model	BS3	BS6	BS1
Appearance			
WXHxD(mm)	96 X 48 X 100	72 X 36 X 100	48 X 24 X 100
Function	Indicator		
Power supply	100 – 220 V a.c. 50 – 60 Hz (voltage variation rate ±10 %)		
Display unit	V · mV · A · mA · μA		
Max. display range	1999 (3½ Digit)		
Input signal	AC voltage, AC current, DC voltage, DC current, Instrumentation signal		
A/D converter	2 dual integration		
Sampling cycle	300 ms		
Response speed	Approx. 2 sec. (Max. range)		
Insulation resistance	Min. 100 MΩ at 500 V d.c. between terminals		
Dielectric strength	1500 V a.c. for 1 minute between power and external terminals		
Vibration	Mechanical Durability	10 – 55 Hz each direction for 1 hour	
	Malfunction Resistance	10 – 55 Hz each direction for 10 minutes	
Shock	Mechanical Durability	300 % X·Y·Z each direction 3 times (Approx. 30G)	
	Malfunction Resistance	100 % X·Y·Z each direction 3 times (Approx. 10G)	
Ambient Temp. & Humidity		0 ~ 50 °C / 35 ~ 85 % RH	

Suffix code

Model	Code	Information	
BS	□ □ □ □ □	Digital panel meter	
Dimension	6	72 X 36 mm	
	3	96 X 48 mm	
	1	48 X 24 mm	
Output	N	Only for indication	
Input type	A	10	AC voltmeter (AC)
		20	AC ammeter (AC)
		20	DC voltmeter(DC)
	D	20	DC ammeter(DC)
		11	DC voltmeter
		21	DC ammeter
Measurement range	1	Refer to the measurement range code : BS3-NA101 (1,999 V)	

※Mode: range code of BS6 and BS3 are different

■ DC voltage (model: BS3, BS6, BS1)

Model	Input range	Display range	Input impedance	Allowable max input voltage
BS □-ND111	1 – 5 V d.c.	50.0	500 kΩ	100 V
BS □-ND112		100.0	500 kΩ	100 V
BS □-ND113		199.9	500 kΩ	100 V

Input Measurement range 0 – 10 V d.c. (optional)

■ AC voltage (model: BS3)

Model	Measurement range	Resolving power	Input impedance	Allowable max input voltage
BS3-NA101	1,999 V	1 mV	100 kΩ	10 V
BS3-NA102	19.99 V	10 mV	1 MΩ	50 V
BS3-NA103	199.9 V	100 mV	10 MΩ	300 V
BS3-NA104	400 V	1 V	10 MΩ	500 V
BS6-NA105	400 V	1 V	10 MΩ	500 V

■ AC voltage (model: BS6, BS1)

Model	Measurement range	Resolving power	Input impedance	Allowable max input voltage
BS □-NA101	199.9 mV	0.1 mV	10 kΩ	10 V
BS □-NA102	1,999 V	1 mV	100 kΩ	10 V
BS □-NA103	19.99 V	10 mV	1 MΩ	50 V
BS □-NA104	199.9 V	100 mV	10 MΩ	300 V
BS6-NA105	400 V	1 V	10 MΩ	500 V
BS1-NA105	500 V			

※BS1-NA105 range : 500 V

■ DC ammeter (model: BS3, BS6, BS1)

Model	Input range	Display range	Input impedance	Allowable max input voltage
BS □-ND211	4 – 20 mA d.c.	50.0	25 Ω	150 mA
BS □-ND212		100.0	50 Ω	150 mA
BS □-ND213		199.9	100 Ω	150 mA

■ DC current (model: BS3, BS6, BS1)

Model	Measurement range	Resolving power	Input impedance	Allowable max input voltage
BS□-ND101	199.9 mV	0.1 mV	10 kΩ	70 V
BS□-ND102	1,999 V	1 mV	100 kΩ	100 V
BS□-ND103	19.99 V	10 mV	1 MΩ	200 V
BS□-ND104	199.9 V	100 mV	10 MΩ	300 V
BS□-ND105	500 V	1 V	10 MΩ	600 V

■ DC current (model: BS6)

Model	Measurement range	Resolving power	Input impedance	Allowable max input voltage
BS6-ND201	199.9 μA	0.1 μA	100 Ω	1 mA
BS6-ND202	1,999 mA	1 μA	10 Ω	50 mA
BS6-ND203	19.99 mA	10 μA	1 Ω	150 mA
BS6-ND204	199.9 mA	100 μA	0.1 Ω	300 mA
BS6-ND205	5.00 A	10 mA	400 MΩ	5.1 A
BS6-ND206	19.99 A	10 mA	Use shunt (Secondary voltage 50 mV)	
BS6-ND207	199.9 A	100 mA		
BS6-ND208	1999 A	1 A		

Measurement range

■ AC current (model: BS3, BS6, BS1)

Model	Measurement range	Resolving power	Input impedance	Allowable max input voltage
BS □ - NA201	19.99 mA	10 μA	10 Ω	50 mA
BS □ - NA202	199.9 mA	100 μA	1 Ω	300 mA
BS □ - NA203	1,999 A	1 mA	0.1 Ω	3 A
BS □ - NA204	5.00 A	10 mA	40 MΩ	5.1 A
BS □ - NA205	19.99 A	10 mA	Use transformer (Secondary current 5 A)	
BS □ - NA206	30.0 A	100 mA		
BS □ - NA207	100.0 A	100 mA		
BS □ - NA208	150.0 A	100 mA		
BS □ - NA209	199.9 A	100 mA		
BS □ - NA210	300 A	1 A		
BS □ - NA211	1999 A	1 A		

■ DC current (model: BS1)

Model	Measurement range	Resolving power	Input impedance	Allowable max input voltage
BS1-ND201	199.9 μA	0.1 μA	1 kΩ	50 mA
BS1-ND202	1,999 mA	1 μA	100 Ω	150 mA
BS1-ND203	19.99 mA	10 μA	10 Ω	300 mA
BS1-ND204	199.9 mA	100 μA	1 Ω	3 A
BS1-ND205	1,999 A	1 mA	0.1 Ω	3 A
BS1-ND206	5.00 A	10 mA	0.01 Ω	5 A
BS1-ND207	19.99 A	10 mA	Use shunt (Secondary voltage 50 mV)	
BS1-ND208	199.9 A	100 mA		
BS1-ND209	1999 A	1 A		

■ DC ammeter current (model: BS3)

Model	Measurement range	Resolving power	Input impedance	Allowable max input voltage
BS3-ND201	1,999 mA	1 μA	100 Ω	50 mA
BS3-ND202	19.99 mA	10 μA	10 Ω	150 mA
BS3-ND203	199.9 mA	100 μA	1 Ω	300 mA
BS3-ND204	1,999 A	1 mA	0.1 Ω	3 A
BS3-ND205	5.00 A	10 mA	0.01 Ω	5 A
BS3-ND206	19.99 A	10 mA	Use shunt (Secondary voltage 50 mV)	
BS3-ND207	199.9 A	100 mA		
BS3-ND208	1999 A	1 A		

Panel Meter

BA1 Digital Voltmeter-Ammeter

Specification

Model	BA1	
Appearance		
WXHD(mm)	48 X 24 X 53	
Function	Display	
Power supply	5 V d.c., 12 – 24 V d.c.	
Display unit	-	
Max. range	±1999 (3½ Digit)	
Input signal	DC voltage, DC current, Instrumentation signal	
A/D converter	2 dual integration	
Sampling cycle	2.5 times / sec.	
Response speed	Approx. 2.5sec.	
Insulation resistance	Min. 100 MΩ at 500 V d.c. between external terminal and case	
Dielectric strength	1500 V a.c. for 1 minute between power and external terminals	
Vibration	Malfunction Resistance	10 – 55 Hz 0.76 mm X-Y-Z each direction for 2 hours
	Mechanical Durability	2 – 55 Hz X-Y-Z each direction for 10 minutes
Shock	Malfunction Resistance	100 % each direction 3 times (Approx. 10G)
	Mechanical Durability	300 % each direction 3 times (Approx. 30G)
Ambient temp. & Humidity		0 ~ 50 °C / 35 ~ 85 % RH (Without condensation)

Suffix code

Model	Code	Information
BA1-	<input type="checkbox"/> <input type="checkbox"/> <input type="checkbox"/> <input type="checkbox"/>	Mini DC indicator (48 X 24 mm)
Input	D 10	DC voltage (voltmeter)
	D 20	DC current (ammeter)
	D 11	DC voltmeter (1 – 5 V d.c.)
	D 21	DC ammeter (4 – 20 mA d.c.)
Range code		Refer to the Measurement range
Power supply voltage	-	5 V d.c.
	A	12 – 24 V d.c.

Measurement range

DC voltage

Model	Measurement range	Resolving power	Input impedance	Max allowable input voltage
BA1-D101	199.9 mV	100 μV	100 kΩ	70 V
BA1-D102	1,999 V	1 mV	1 MΩ	100 V
BA1-D103	19.99 V	10 mV	1 MΩ	250 V
BA1-D104	199.9 V	100 mV	10 MΩ	300 V
BA1-D111	1 – 5 V d.c.	50.0	100 kΩ	100 V
BA1-D112		100.0	100 kΩ	100 V
BA1-D113		199.9	100 kΩ	100 V

* Degree : Indicate value of ±0.2 % ±1 digit (23 °C ±5 °C)

DC current

Model	Measurement range	Resolving power	Input impedance	Max allowable input voltage
BA1-D201	199.9 μA	0.1 μA	1 kΩ	10 mA
BA1-D202	1,999 mA	1 μA	100 Ω	50 mA
BA1-D203	19.99 mA	10 μA	10 Ω	150 mA
BA1-D204	199.9 mA	100 μA	1 Ω	500 mA
BA1-D205	1,999 A	1 mA	0.01 Ω	5 A
BA1-D206	19.99 A	10 mA	Use shunt (secondary voltage 50 mV)	
BA1-D207	199.9 A	100 mA		
BA1-D208	1999 A	1 A		
BA1-D211	4 – 20 mA d.c.	50.0	25 Ω	150 mA
BA1-D212		100.0	50 Ω	150 mA
BA1-D213		199.9	100 Ω	150 mA

* Degree : Indicate value of ±0.2 % ±1 digit (23 °C ±5 °C)

HLP1 Non voltage digital scale meter

Specification

Model	HLP1	
Appearance		
W X H X D (mm)	48 X 25 X 50	
Power supply voltage	Non-voltage type	
Ambient temperature	-5 ~ 50 °C	
Ambient humidity	20 ~ 90 % RH	
Storage temperature	-25 ~ 70 °C	
Vibration resistance	10 ~ 55 Hz Single amplitude for 2 hour each in X, Y and Z direction	
Shock resistance	300 m/s ² , 3 times each in X, Y and Z 6 direction	

■ UP series Round type proximity sensor

■ Specification

■ Inductive DC 3 wire type

Model	NPN	UP8RM-1.5N□□	UP8RD-2N□□	UP12RM-2N□□	UP12RD-4N□□
	PNP	UP8RM-1.5P□□	UP8RD-2P□□	UP12RM-2P□□	UP12RD-4P□□
Appearance					
Shield	Shield	Non shield	Shield	Non shield	
Standard sensing object(mm)	Iron 8 X 8 X 1			Iron 12 X 12 X 1	
Sensing distance	1.5 mm	2 mm	2 mm	4 mm	
Setting distance	0 ~ 1.2 mm	0 ~ 1.6 mm	0 ~ 1.6 mm	0 ~ 3.2 mm	
Hysteresis	Less than 10% of sensing distance				
Response frequency	800 Hz		800 Hz	400 Hz	
Power supply voltage	12 - 24 V d.c. (Usable voltage range 5 - 35 V d.c.)				
Control output	200 mA max (Resistive load)				
Residual voltage	Max 1.5 V				
Current consumption	Max 6 mA				
Operation indication	Red LED				
Protection circuit	Power reversely connected protective circuit, Surge protective circuit and Over current protective circuit are built in.				
Ambient temperature	-25 ~ 70 °C (Less than ±10 % of sensing distance at temperature 20 °C)				
Ambient humidity	35 ~ 85 %RH				
Insulation resistance	min 50 MΩ (500 V d.c. mega standard)				
Dielectric strength	For 1 min at 2,000 V a.c. 50/60 Hz (between the recharging part and case)				
Vibration resistance	10 - 55 Hz (cycle 1 min, double amplitude: 1.5 mm 2 hours for each of X, Y and Z directions)				
Shock resistance	500 % 3 times to each of X, Y and Z directions				
Degree of protection	IP67(IEC standard)				
Connection structure	Cable type (standard cable length 2 m), relay connector type, connector type				
Color	NPN : Green, PNP : Purple				
Material	Case: stainless, Sensing surface: PBT, Cable holder: Polyester elastomer		Case: brass (chrome plating), Sensing surface: PBT, Cable holder: Polyester elastomer		

■ Inductive DC 3 wire type

Model	NPN	UP18RM-5N□□	UP18RD-8N□□	UP18RLM-5N□□	UP18RLD-8N□□
	PNP	UP18RM-5P□□	UP18RD-8P□□	UP18RLM-5P□□	UP18RLD-8P□□
Appearance					
Shield	Shield	Non shield	Shield	Non shield	
Standard sensing object(mm)	Iron 18×18×1	Iron 25×25×1	Iron 18×18×1	Iron 25×25×1	
Sensing distance	5 mm	8 mm	5 mm	8 mm	
Setting distance	0 ~ 4 mm	0 ~ 6.4 mm	0 ~ 4 mm	0 ~ 6.4 mm	
Hysteresis	Less than 10% of sensing distance				
Response frequency	350 Hz	200 Hz	350 Hz	200 Hz	
Power supply voltage	12 - 24 V d.c. (Usable voltage range 5 - 35 V d.c.)				
Control output	200 mA max (Resistive load)				
Residual voltage	Max 1.5 V				
Current consumption	Max 6 mA				
Operation indication	Red LED				
Protection circuit	Power reversely connected protective circuit, Surge protective circuit and Over current protective circuit are built in.				
Ambient temperature	-25 ~ 70 °C (Less than ±10 % of sensing distance at temperature 20 °C)				
Ambient humidity	35 ~ 85 % RH				
Insulation resistance	min 50 MΩ (500 V d.c. mega standard)				
Dielectric strength	For 1 min at 2,000 V a.c. 50/60 Hz (between the recharging part and case)				
Vibration resistance	10 - 55 Hz (cycle 1 min, double amplitude: 1.5 mm 2 hours for each of X, Y and Z directions)				
Shock resistance	500 % 3 times to each of X, Y and Z directions				
Degree of protection	IP67(IEC standard)				
Connection structure	Cable type (standard cable length 2 m), relay connector type, connector type				
Color	NPN : Green, PNP : Purple				
Material	Case: brass (chrome plating), Sensing surface : PBT, Cable holder: Polyester elastomer				

Proximity Sensor

■ Inductive DC 3 wire type

Model	NPN	UP30RM-10N□□	UP30RD-15N□□	UP30RLM-10N□□	UP30RLD-15N□□	
	PNP	UP30RM-10P□□	UP30RD-15P□□	UP30RLM-10P□□	UP30RLD-15P□□	
Appearance						
Shield	Shield		Non shield		Shield	
Standard sensing object(mm)	Iron 30×30×1		Iron 45×45×1		Iron 30×30×1	
Sensing distance	10 mm		15 mm		10 mm	
Setting distance	0 ~ 8 mm		0 ~ 12 mm		0 ~ 8 mm	
Hysteresis	Less than 10% of sensing distance					
Response frequency	250 Hz		100 Hz		250 Hz	
Power supply voltage	12 - 24 V d.c. (Usable voltage range 5 - 35 V d.c.)					
Control output	200 mA max (Resistive load)					
Residual voltage	Max 1.5 V					
Current consumption	Max 6 mA					
Operation indication	Red LED					
Protection circuit	Power reversely connected protective circuit, Surge protective circuit and Over current protective circuit are built in.					
Ambient temperature	-25 ~ 70 °C (Less than ±10 % of sensing distance at temperature 20 °C)					
Ambient humidity	35 ~ 85 %RH					
Insulation resistance	min 50 MΩ (500 V d.c. mega standard)					
Dielectric strength	For 1 min at 2000 V a.c. 50/60 Hz (between the recharging part and case)					
Vibration resistance	10 - 55 Hz (cycle 1 min, double amplitude: 1.5 mm 2 hours for each of X, Y and Z directions)					
Shock resistance	500 % 3 times to each of X, Y and Z directions					
Degree of protection	IP67(IEC standard)					
Connection structure	Cable type (standard cable length 2 m), relay connector type, connector type					
Color	NPN : Green, PNP : Purple					
Material	Case: brass (chrome plating), Sensing surface : PBT, Cable holder: Polyester elastomer					

■ Inductive DC 2 wire type (Polarity / No polarity)

Model	Polar	UP8RM-1.5T□□	UP8RD-2T□□	UP12RM-2T□□	UP12RD-4T□□	
	No polarity	UP8RM-1.5U□□	UP8RD-2U□□	UP12RM-2U□□	UP12RD-4U□□	
Appearance						
Shield	Shield		Non shield		Shield	
Standard sensing object(mm)	Iron 8×8×1		Iron 8×8×1		Iron 12×12×1	
Sensing distance	1.5 mm		2 mm		2 mm	
Setting distance	0 ~ 1.2 mm		0 ~ 1.6 mm		0 ~ 1.6 mm	
Hysteresis	Less than 10% of sensing distance					
Response frequency	800 Hz		800 Hz		800 Hz	
Power supply voltage	12 - 24 V d.c. (Usable voltage range 5 - 35 V d.c.)					
Control output	100 mA max (Resistive load)					
Residual voltage	T (Polarity) : max 3.5 V, U (No polarity) : max 5 V					
Leakage current	Max 1 mA					
Operation indication	Red LED					
Protection circuit	Surge protective circuit and Over current protective circuit are built in.					
Ambient temperature	-25 ~ 70 °C (Less than ±10 % of sensing distance at temperature 20 °C)					
Ambient humidity	35 ~ 85 % RH					
Insulation resistance	min 50 MΩ (500 V d.c. mega standard)					
Dielectric strength	For 1 min at 2000 V a.c. 50/60 Hz (between the recharging part and case)					
Vibration resistance	10 - 55 Hz (cycle 1 min, double amplitude: 1.5 mm 2 hours for each of X, Y and Z directions)					
Shock resistance	500 % 3 times to each of X, Y and Z directions					
Degree of protection	IP67(IEC standard)					
Connection structure	Cable type (standard cable length 2 m), relay connector type, connector type					
Color	NO : Green, NC : Purple					
Material	Case: stainless, Sensing surface: PBT, Cable holder: Polyester elastomer			Case: brass (chrome plating), Sensing surface: PBT, Cable holder: Polyester elastomer		

Proximity Sensor

■ Inductive DC 2 wire type (Polarity / No polarity)



Model	Polar	UP18RM-5T□□	UP18RD-8T□□	UP18RLM-5T□□	UP18RLD-8T□□
	No polarity	UP18RM-5U□□	UP18RD-8U□□	UP18RLM-5U□□	UP18RLD-8U□□
Appearance					
Shield		Shield	Non shield	Shield	Non shield
Standard sensing object(mm)		Iron 18×18×1	Iron 25×25×1	Iron 18×18×1	Iron 25×25×1
Sensing distance		5 mm	8 mm	5 mm	8 mm
Setting distance		0 ~ 4 mm	0 ~ 6.4 mm	0 ~ 4 mm	0 ~ 6.4 mm
Hysteresis		Less than 10% of sensing distance			
Response frequency		800 Hz	400 Hz	800 Hz	400 Hz
Power supply voltage		12 - 24 V d.c. (Usable voltage range 5 - 35 V d.c.)			
Control output		100 mA max (Resistive load)			
Residual voltage		T (Polarity) : max 3.5 V, U (No polarity) : max 5 V			
Leakage current		Max 1 mA			
Operation indication		Red LED			
Protection circuit		Surge protective circuit and Over current protective circuit are built in.			
Ambient temperature		-25 ~ 70 °C (Less than ±10 % of sensing distance at temperature 20 °C)			
Ambient humidity		35 ~ 85 % RH			
Insulation resistance		min 50 MΩ (500 V d.c. mega standard)			
Dielectric strength		For 1 min at 2,000 V a.c. 50/60 Hz (between the recharging part and case)			
Vibration resistance		10 - 55 Hz (cycle 1 min, double amplitude: 1.5 mm 2 hours for each of X, Y and Z directions)			
Shock resistance		500 % 3 times to each of X, Y and Z directions			
Degree of protection		IP67(IEC standard)			
Connection structure		Cable type (standard cable length 2 m), relay connector type, connector type			
Color		NO : Green, NC : Purple			
Material		Case : brass (chrome plating), Sensing surface : PBT, Cable holder : Polyester elastomer			

■ Inductive DC 2 wire type (Polarity / No polarity)

Model	Polar	UP30RM-10T□□	UP30RD-15T□□	UP30RLM-10T□□	UP30RLD-15T□□
	No polarity	UP30RM-10U□□	UP30RD-15U□□	UP30RLM-10U□□	UP30RLD-15U□□
Appearance					
Shield		Shield	Non shield	Shield	Non shield
Standard sensing object(mm)		Iron 30×30×1	Iron 45×45×1	Iron 30×30×1	Iron 45×45×1
Sensing distance		10 mm	15 mm	10 mm	15 mm
Setting distance		0 ~ 8 mm	0 ~ 12 mm	0 ~ 8 mm	0 ~ 12 mm
Hysteresis		Less than 10% of sensing distance			
Response frequency		250 Hz	100 Hz	250 Hz	100 Hz
Power supply voltage		12 - 24 V d.c. (Usable voltage range 5 - 35 V d.c.)			
Control output		100 mA max (Resistive load)			
Residual voltage		T (Polarity) : max 3.5 V, U (No polarity) : max 5 V			
Leakage current		Max 1 mA			
Operation indication		Red LED			
Protection circuit		Surge protective circuit and Over current protective circuit are built in.			
Ambient temperature		-25 ~ 70 °C (Less than ±10 % of sensing distance at temperature 20 °C)			
Ambient humidity		35 ~ 85 % RH			
Insulation resistance		min 50 MΩ (500 V d.c. mega standard)			
Dielectric strength		For 1 min at 2,000 V a.c. 50/60 Hz (between the recharging part and case)			
Vibration resistance		10 - 55 Hz (cycle 1 min, double amplitude: 1.5 mm 2 hours for each of X, Y and Z directions)			
Shock resistance		500 % 3 times to each of X, Y and Z directions			
Degree of protection		IP67(IEC standard)			
Connection structure		Cable type (standard cable length 2 m), relay connector type, connector type			
Color		NO : Green, NC : Purple			
Material		Case : brass (chrome plating), Sensing surface : PBT, Cable holder : Polyester elastomer			

Proximity Sensor

■ Inductive AC 2 wire type

Model	UP12RM-2A□□	UP12RD-4A□□
Appearance		
Shield	Shield	Non shield
Standard sensing object(mm)	Iron 12×12×1	
Sensing distance	2 mm	4 mm
Setting distance	0 ~ 1.6 mm	0 ~ 3.2 mm
Hysteresis	Less than 10 % of sensing distance	
Response frequency	20 Hz	
Power supply voltage	100 - 240 V a.c. (Usable voltage range 90 - 250 V a.c.)	
Control output	200 mA max (Resistive load)	
Residual voltage	max 10 V	
Leakage current	Max 2.2 mA	
Operation indication	Red LED	
Protection circuit	Surge protective circuit built in.	
Ambient temperature	-25 ~ 70 °C (Less than ±10 % of sensing distance at temperature 20 °C)	
Ambient humidity	35 ~ 85 %RH	
Insulation resistance	min 50 MΩ (500 V d.c. mega standard)	
Dielectric strength	For 1 min at 2000 V a.c. 50/60 Hz (between the recharging part and case)	
Vibration resistance	10 - 55 Hz (cycle 1 min, double amplitude: 1.5 mm 2 hours for each of X, Y and Z directions)	
Shock resistance	500 % 3 times to each of X, Y and Z directions	
Degree of protection	IP67(IEC standard)	
Connection structure	Cable type (standard cable length 2 m), relay connector type, connector type	
Color	NO : Green, NC : Purple	
Material	Case : brass (chrome plating), Sensing surface : PBT, Cable holder : Polyester elastomer	

■ Inductive AC 2 wire type

Model	UP18RM-5A□□	UP18RD-8A□□	UP18RLM-5A□□	UP18RLD-8A□□
Appearance				
Shield	Shield	Non shield	Shield	Non shield
Standard sensing object(mm)	Iron 18×18×1	Iron 25×25×1	Iron 18×18×1	Iron 25×25×1
Sensing distance	5 mm	8 mm	5 mm	8 mm
Setting distance	0 ~ 4 mm	0 ~ 6.4 mm	0 ~ 4 mm	0 ~ 6.4 mm
Hysteresis	Less than 10 % of sensing distance			
Response frequency	20 Hz			
Power supply voltage	100 - 240 V a.c. (Usable voltage range 90 - 250 V a.c.)			
Control output	200 mA max (Resistive load)			
Residual voltage	max 10 V			
Leakage current	Max 2.2 mA			
Operation indication	Red LED			
Protection circuit	Surge protective circuit built in.			
Ambient temperature	-25 ~ 70 °C (Less than ±10 % of sensing distance at temperature 20 °C)			
Ambient humidity	35 ~ 85 %RH			
Insulation resistance	min 50 MΩ (500 V d.c. mega standard)			
Dielectric strength	For 1 min at 2,000 V a.c. 50/60 Hz (between the recharging part and case)			
Vibration resistance	10 - 55 Hz (cycle 1 min, double amplitude: 1.5 mm 2 hours for each of X, Y and Z directions)			
Shock resistance	500 % 3 times to each of X, Y and Z directions			
Degree of protection	IP67(IEC standard)			
Connection structure	Cable type (standard cable length 2 m), relay connector type, connector type			
Color	NO : Green, NC : Purple			
Material	Case : brass (chrome plating), Sensing surface : PBT, Cable holder : Polyester elastomer			

Proximity Sensor

■ Inductive AC 2 wire type

Model	UP30RM-10A□□	UP30RD-15A□□	UP30RLM-10A□□	UP30RLD-15A□□
Appearance				
Shield	Shield	Non shield	Shield	Non shield
Standard sensing object(mm)	Iron 30×30×1	Iron 45×45×1	Iron 30×30×1	Iron 45×45×1
Sensing distance	10 mm	15 mm	10 mm	15 mm
Setting distance	0 ~ 8 mm	0 ~ 12 mm	0 ~ 8 mm	0 ~ 12 mm
Hysteresis	Less than 10 % of sensing distance			
Response frequency	20 Hz			
Power supply voltage	100 - 240 V a.c. (Usable voltage range 90 - 250 V a.c.)			
Control output	200 mA max (Resistive load)			
Residual voltage	max 10 V			
Leakage current	Max 2.2 mA			
Operation indication	Red LED			
Protection circuit	Surge protective circuit built in.			
Ambient temperature	-25 ~ 70 °C (Less than ±10 % of sensing distance at temperature 20 °C)			
Ambient humidity	35 ~ 85 % RH			
Insulation resistance	min 50 MΩ (500 V d.c. mega standard)			
Dielectric strength	For 1 min at 2,000 V a.c. 50/60 Hz (between the recharging part and case)			
Vibration resistance	10 - 55 Hz (cycle 1 min, double amplitude: 1.5 mm 2 hours for each of X, Y and Z directions)			
Shock resistance	500 % 3 times to each of X, Y and Z directions			
Degree of protection	IP67(IEC standard)			
Connection structure	Cable type (standard cable length 2 m), relay connector type, connector type			
Color	NO : Green, NC : Purple			
Material	Case : brass (chrome plating), Sensing surface : PBT, Cable holder : Polyester elastomer			

■ Suffix code



Model	Code	Information
UP	<input type="checkbox"/> <input type="checkbox"/> <input type="checkbox"/> <input type="checkbox"/> <input type="checkbox"/> <input type="checkbox"/>	Inductive type proximity sensor
Sensing area size	8	M8
	12	M12
	18	M18
	30	M30
Structure type	RM	Round type Shield
	RD	Round type Non Shield
	RLM	Long round type Shield (M8 and M12 are excluded)
	RLD	Long round type Non Shield (M8 and M12 are excluded)
Sensing distance	*	Please refer to the sensing distance of each specification (unit : mm)
Power and output type	N	DC NPN output
	P	DC PNP output
	A	AC 2 wire type
	T	DC 2 wire type (Polarity)
	U	DC 2 wire type (No polarity) ※ But M8 is excluded
Output state	A	Normal Open (N.O)
	C	Normal Close (N.C)
Connection structure	*	Cable type
	CR	Relay connector type
	C	Connector type

Proximity Sensor



■ UP series Square type proximity sensor

■ Specification

■ Inductive DC 3 wire type



Model	NPN	UP12S-4N □□	UP18S-5N □□	UP18S-8N □□
	PNP	UP12S-4P □□	UP18S-5P □□	UP18S-8P □□
Appearance				
Standard sensing object(mm)	Iron 12X12X1		Iron 18X18X1	Iron 25X25X1
Sensing distance	4 mm		5 mm	8 mm
Setting distance	0 ~ 3,2 mm		0 ~ 4 mm	0 ~ 6,4 mm
Hysteresis	Less than 10 % of sensing distance			
Response frequency	800 Hz			
Power supply voltage	12 - 24 V d.c. (Usable voltage range 5 - 35 V d.c.)			
Control output	Open/Close capacitance	200 mA max (Resistive load)		
	Residual voltage	1.5 V max		
Current consumption	6 mA max			
Operation indication	Red LED			
Protective circuit	Power reversely connected protective circuit, Surge protective circuit and over current protective circuit are built in.			
Degree of protection	IP67(IEC standard)			
Connection structure	Cable type (standard cable length 2 m), Relay connector type			
Ambient temperature	-25 ~ 70 °C (Less than ±10 % of sensing distance at temperature 20 °C)			
Ambient humidity	35 ~ 85 %RH			
Insulation resistance	Min 50 MΩ (500 V d.c. mega standard)			
Dielectric strength	For 1 min at 2000 V a.c. 50/60 Hz (Between the recharging part and case)			
Vibration resistance	10 - 55 Hz (Cycle 1 min, Double amplitude : 1.5 mm 2 hours for each of X, Y and Z directions)			
Shock resistance	500 % 3 times to each of X, Y and Z directions			
Material	Case : PBT resin, cable holder : Polyester elastomer			
Weight	Cable type	approx. 45g	approx. 60g	approx. 60g
	Relay connector type	approx. 15g	approx. 20g	approx. 20g

■ Inductive DC 3 wire type



Model	NPN	UP25S-5N □□	UP25S-8N □□	UP25S-12N □□	UP30S-10N □□	UP30S-15N □□	UP40S-20N □□
	PNP	UP25S-5P □□	UP25S-8P □□	UP25S-12P □□	UP30S-10P □□	UP30S-15P □□	UP40S-20P □□
Appearance							
Standard sensing object(mm)	Iron 25 X 25 X 1	Iron 30 X 30 X 1	Iron 35 X 35 X 1	Iron 30 X 30 X 1	Iron 45 X 45 X 1	Iron 60 X 60 X 1	
Sensing distance	5 mm	8 mm	12 mm	10 mm	15 mm	20 mm	
Setting distance	0 ~ 4 mm	0 ~ 6,4 mm	0 ~ 9,6 mm	0 ~ 8 mm	0 ~ 12 mm	0 ~ 16 mm	
Hysteresis	Less than 10% of sensing distance						
Response frequency	350 Hz	250 Hz	200 Hz	250 Hz	100 Hz	100 Hz	
Power supply voltage	12 - 24 V d.c. (Usable voltage range 5 - 35 V d.c.)						
Control output	Open/Close capacitance	200 mA max (Resistive load)					
	Residual voltage	1.5 V max					
Current consumption	6 mA max						
Operation indication	Red LED						
Protective circuit	Power reversely connected protective circuit, Surge protective circuit and over current protective circuit are built in.						
Degree of protection	IP67(IEC standard)						
Connection structure	Cable type (standard cable length 2 m), Relay connector type						
Ambient temperature	-25 ~ 70 °C (Less than ±10 % of sensing distance at temperature 20 °C)						
Ambient humidity	35 ~ 85 % RH						
Insulation resistance	Min 50 MΩ (500 V d.c. mega standard)						
Dielectric strength	For 1 min at 2,000 V a.c. 50/60 Hz (Between the recharging part and case)						
Vibration resistance	10 - 55 Hz (Cycle 1 min, Double amplitude : 1.5 mm 2 hours for each of X, Y and Z directions)						
Shock resistance	500 % 3 times to each of X, Y and Z directions						
Material	Case : PBT resin, Cable holder : Polyester elastomer						
Weight	Cable type	approx. 80g	approx. 80g	approx. 80g	approx. 90g	approx. 90g	approx. 110g
	Relay connector type	approx. 40g	approx. 40g	approx. 40g	approx. 60g	approx. 60g	approx. 80g

Proximity Sensor

■ Inductive DC 2 wire type



Model	Polarity	UP12S-4T □□	UP18S-5T □□	UP18S-8T □□
	Non polarity	UP12S-4U □□	UP18S-5U □□	UP18S-8U □□
Appearance				
Standard sensing object(mm)		Iron 12X12X1	Iron 18X18X1	Iron 25X25X1
Sensing distance		4 mm	5 mm	8 mm
Setting distance		0 ~ 3.2 mm	0 ~ 4 mm	0 ~ 6.4 mm
Hysteresis		Less than 10 % of sensing distance		
Response frequency		500 Hz	500 Hz	300 Hz
Power supply voltage		12 - 24 V d.c. (Usable voltage range 10 - 30 V d.c.)		
Control output	Open/Close capacitance	100 mA max (Resistive load)		
	Residual voltage	1.5 V max		
Leakage current		6 mA max		
Operation indication		Red LED		
Protective circuit		Power reversely connected protective circuit, Surge protective circuit and over current protective circuit are built in.		
Degree of protection		IP67(IEC standard)		
Connection structure		Cable type (standard cable length 2 m), Relay connector type		
Ambient temperature		-25 ~ 70 °C (Less than ±10 % of sensing distance at temperature 20 °C)		
Ambient humidity		35 ~ 85 %RH		
Insulation resistance		Min 50 MΩ (500 V d.c. mega standard)		
Dielectric strength		For 1 min at 2,000 V a.c. 50/60 Hz (Between the recharging part and case)		
Vibration resistance		10 - 55 Hz (Cycle 1 min, Double amplitude : 1.5 mm 2 hours for each of X, Y and Z directions)		
Shock resistance		500 % 3 times to each of X, Y and Z directions		
Weight	Material	Case : PBT resin, Cable holder : Polyester elastomer		
	Cable type	approx. 45g	approx. 60g	approx. 60g
	Relay connector type	approx. 15g	approx. 20g	approx. 20g

■ Inductive DC 2 wire type



Model	Polarity	UP25S-5T □□	UP25S-8T □□	UP25S-12T □□	UP30S-10T □□	UP30S-15T □□	UP40S-20T □□
	Non polarity	UP25S-5U □□	UP25S-8U □□	UP25S-12U □□	UP30S-10U □□	UP30S-15U □□	UP40S-20U □□
Appearance							
Standard sensing object(mm)		Iron 25 X 25 X 1	Iron 30 X 30 X 1	Iron 35 X 35 X 1	Iron 30 X 30 X 1	Iron 45 X 45 X 1	Iron 60 X 60 X 1
Sensing distance		5 mm	8 mm	12 mm	10 mm	15 mm	20 mm
Setting distance		0 ~ 4 mm	0 ~ 6.4 mm	0 ~ 9.6 mm	0 ~ 8 mm	0 ~ 12 mm	0 ~ 16 mm
Hysteresis		Less than 10 % of sensing distance					
Response frequency		350 Hz	250 Hz	200 Hz	250 Hz	100 Hz	100 Hz
Power supply voltage		12 - 24 V d.c. (Usable voltage range 10 - 30 V d.c.)					
Control output	Open/Close capacitance	100 mA max (Resistive load)					
	Residual voltage	T (Polarity): max 3.5V, U (Non polarity): max 5V					
Leakage current		Max 1 mA					
Operation indication		Red LED					
Protective circuit		Power reversely connected protective circuit, Surge protective circuit and over current protective circuit are built in.					
Degree of protection		IP67 (IEC standard)					
Connection structure		Cable type (standard cable length 2 m), Relay connector type					
Ambient temperature		-25 ~ 70 °C (Less than ±10 % of sensing distance at temperature 20 °C)					
Ambient humidity		35 ~ 85 %RH					
Insulation resistance		Min 50 MΩ (500 V d.c. mega standard)					
Dielectric strength		For 1 min at 2,000 V a.c. 50/60 Hz (Between the recharging part and case)					
Vibration resistance		10 - 55 Hz (Cycle 1 min, Double amplitude : 1.5 mm 2 hours for each of X, Y and Z directions)					
Shock resistance		500 % 3 times to each of X, Y and Z directions					
Weight	Material	Case : PBT resin, Cable holder : Polyester elastomer					
	Cable type	approx. 80g	approx. 80g	approx. 80g	approx. 90g	approx. 90g	approx. 110g
	Relay connector type	approx. 40g	approx. 40g	approx. 40g	approx. 60g	approx. 60g	approx. 80g

Proximity Sensor

■ Inductive AC 2 wire type

Model	For AC	UP25S-5A □ □	UP25S-8A □ □	UP30S-10A □ □
Appearance		CE 		CE 
	Standard sensing object(mm)	Iron 25 X 25 X 1		Iron 30 X 30 X 1
Sensing distance		5 mm	8 mm	10 mm
Setting distance		0 ~ 4 mm	0 ~ 6.4 mm	0 ~ 8 mm
Hysteresis		Less than 10% of sensing distance		
Response frequency		20 Hz		
Power supply voltage		100 - 240 V a.c. (Usable voltage range 90 - 250 V a.c.)		
Control output	Open/Close capacitance	200 mA max (Resistive load)		
	Residual voltage	Max 10 V a.c.		
Leakage current		Max 2.2 mA		
Operation indication		Red LED		
Protective circuit		Surge protective circuit is built in.		
Degree of protection		IP67(IEC standard)		
Connection structure		Cable type (Standard cable length 2 m), Relay connector type		
Ambient temperature		-25 ~ 70 °C (Less than ±10 % of sensing distance at temperature 20 °C)		
Ambient humidity		35 ~ 85 %RH		
Insulation resistance		Min 50 MΩ (500 V d.c. mega standard)		
Dielectric strength		For 1 min at 2,000 V a.c. 50/60 Hz (Between the recharging part and case)		
Vibration resistance		10 - 55 Hz (Cycle 1 min, Double amplitude : 1.5 mm 2 hours for each of X, Y and Z directions)		
Shock resistance		500 % 3 times to each of X, Y and Z directions		
Material		Case : PBT resin, Cable holder : Polyester elastomer		
Weight	Cable type	approx. 80g	approx. 80g	approx. 90g
	Relay connector type	approx. 40g	approx. 40g	approx. 80g

■ Inductive AC 2 wire type

Model	For AC	UP30S-15A □ □	UP40S-20A □ □
Appearance		CE 	CE 
	Standard sensing object(mm)	Iron 45 X 45 X 1	Iron 60 X 60 X 1
Sensing distance		15 mm	20 mm
Setting distance		0 ~ 12 mm	0 ~ 16 mm
Hysteresis		Less than 10 % of sensing distance	
Response frequency		20 Hz	
Power supply voltage		100 - 240 V a.c. (Usable voltage range 90 - 250 V a.c.)	
Control output	Open/Close capacitance	200 mA max (Resistive load)	
	Residual voltage	Max 10 V a.c.	
Leakage current		Max 2.2 mA	
Operation indication		Red LED	
Protective circuit		Surge protective circuit is built in.	
Degree of protection		IP67(IEC standard)	
Connection structure		Cable type (Standard cable length 2 m), Relay connector type	
Ambient temperature		-25 ~ 70 °C (Less than ±10 % of sensing distance at temperature 20 °C)	
Ambient humidity		35 ~ 85 % RH	
Insulation resistance		Min 50 MΩ (500 V d.c. mega standard)	
Dielectric strength		For 1 min at 2,000 V a.c. 50/60 Hz (Between the recharging part and case)	
Vibration resistance		10 - 55 Hz (Cycle 1 min, Double amplitude : 1.5 mm 2 hours for each of X, Y and Z directions)	
Shock resistance		500 % 3 times to each of X, Y and Z directions	
Material		Case : PBT resin, Cable holder : Polyester elastomer	
Weight	Cable type	approx. 90g	approx. 110g
	Relay connector type	approx. 60g	approx. 80g

Proximity Sensor

Suffix code



Model	Code					Information	
UP	<input type="checkbox"/>	S	<input type="checkbox"/>	<input type="checkbox"/>	<input type="checkbox"/>	Inductive type proximity sensor	
Sensing area size	12					12 X 12 mm	Temperature Controller
	18					18 X 18 mm	
	25					25 X 25 mm	
	30					30 X 30 mm	
	40					40 X 40 mm	Recorder
Structure type	S					Square type	
Sensing distance	2					2 mm (Only with UP8S-2)	Digital Counter
	4					4 mm (Only with UP12S-4)	Timer
	5					5 mm (Only with UP18S-5, UP25S-5)	Analog Timer
	8					8 mm (Only with UP18S-8, UP25S-8)	
	10					10 mm (Only with UP30S-10)	
	12					12 mm (Only with UP25S-12)	
	15					15 mm (Only with UP30S-15)	
Power and output type	20					20 mm (Only with UP40S-20)	Panel Meter
	N					DC NPN output	
	P					DC PNP output	
	A					AC 2 wire type (But UP18S is excluded)	Multi Pulse Meter
	T					DC 2 wire type (Polarity)	
Output state	U					DC 2 wire type (No polarity)	
	A					Normal Open (NO)	Proximity Sensor
Sensing direction	C					Normal Close (NC)	
	*					Detect Front side	
Connection structure	U					Detect upper side (Only available with the square type UP18S)	Photo Sensor
	*					Cable type	
	CR					Relay connector type	Rotary Encoder
							Thyristor Power Regulator
							Solid State Relay
							Power Supply
							Control Switch
							Push Button / Main Switch
							Cam Switch / Limit Switch
							Micro / Hoist Switch
							Foot / Mono Lever Switch
							Signal Light
							Terminal Block / Power Buzzer / Fuse Holder / Control Box

Proximity Sensor



■ UP series Flat type proximity sensor

■ Specification

■ Inductive DC 3 wire type / 2 wire type

Model	DC 3 wire type		DC 2 wire type	
	NPN	UP25F-8N□□	Polarity	UP25F-8T□□
	PNP	UP25F-8P□□	No polarity	UP25F-8U□□
Appearance	 			
Standard sensing object(mm)	Iron 25 X 25 X 1			
Sensing distance	8 mm			
Setting distance	0 ~ 6.4 mm			
Hysteresis	Less than 10 % of sensing distance			
Response frequency	200 Hz			
Power supply voltage	12 - 24 V d.c. (Usable voltage range 5 - 35 V d.c.)		12 - 24 V d.c. (Usable voltage range 10 - 30 V d.c.)	
Control output	200 mA max (Resistive load)		100 mA max (Resistive load)	
Residual voltage	Max 1.5 V		Polarity : max 3.5 V, No polarity : max 5 V	
Current consumption	Max 6 mA		-	
Leakage current	-		max 1 mA	
Operation indication	Red LED			
Protection circuit	Power reversely connected protective circuit, Surge protective circuit and Over current protective circuit are built in.		Surge protective circuit and Over current protective circuit are built in.	
Ambient temperature	-25 ~ 70 °C (Less than ±10 % of sensing distance at temperature 20 °C)			
Ambient humidity	35 ~ 85 %RH			
Insulation resistance	min 50 MΩ (500 V d.c. mega standard)			
Dielectric strength	For 1 min at 2,000 V a.c. 50/60 Hz (between the recharging part and case)			
Vibration resistance	10 - 55 Hz (cycle 1 min, double amplitude: 1.5 mm 2 hours for each of X, Y and Z directions)			
Shock resistance	500 % 3 times to each of X, Y and Z directions			
Degree of protection	IP67(IEC standard)			
Connection structure	Cable type (standard cable length 2 m), relay connector type			
Color	Polarity : Green, No Polarity : Purple			
Material	Case : PBT resin, cable holder : Polyester elastomer			

■ Inductive AC 2 wire type

Model	UP25F-8A□□			
Appearance	 			
Standard sensing object(mm)	Iron 25 X 25 X 1			
Sensing distance	8 mm			
Setting distance	0 ~ 6.4 mm			
Hysteresis	Less than 10% of sensing distance			
Response frequency	20 Hz			
Power supply voltage	100 - 240 V a.c. (Usable voltage range 90 - 250 V a.c.)			
Control output	200 mA max (Resistive load)			
Residual voltage	Max 10 V a.c.			
Leakage current	Max 2.2 mA			
Operation indication	Red LED			
Protection circuit	Surge protective circuit built in.			
Ambient temperature	-25 ~ 70 °C (Less than ±10 % of sensing distance at temperature 20 °C)			
Ambient humidity	35 ~ 85 % RH			
Insulation resistance	min 50 MΩ (500V d.c. mega standard)			
Dielectric strength	For 1 min at 2000 V a.c. 50/60 Hz (between the recharging part and case)			
Vibration resistance	10 - 55 Hz (cycle 1 min, double amplitude: 1.5 mm 2 hours for each of X, Y and Z directions)			
Shock resistance	500 % 3 times to each of X, Y and Z directions			
Degree of protection	IP67(IEC standard)			
Connection structure	Cable type (standard cable length 2 m), relay connector type			
Color	NO : Green, NC : Purple			
Material	Case : PBT resin, cable holder : Polyester elastomer			

Proximity Sensor

Suffix code

Model	Code					Information
UP	<input type="checkbox"/>	F	<input type="checkbox"/>	<input type="checkbox"/>	<input type="checkbox"/>	Inductive type proximity sensor
Sensing area size	25					Please refer to the dimension (25 X 49 X 10 mm)
Structure type	F					Flat type
Sensing distance	8					8 mm
Power and output type		N				DC NPN output
		P				DC PNP output
		A				AC 2 wire type
		T				DC 2 wire type (Polarity)
		U				DC 2 wire type (No polarity)
Output state		A				Normal Open (NO)
		C				Normal Close (NC)
Connection structure		*				Cable type
		CR				Relay connector



Temperature Controller
Recorder
Digital Counter
Timer
Analog Timer
Panel Meter
Multi Pulse Meter
Proximity Sensor
Photo Sensor
Rotary Encoder
Thyristor Power Regulator
Solid State Relay
Power Supply
Control Switch
Push Button / Main Switch
Cam Switch / Limit Switch
Micro / Hoist Switch
Foot / Mono Lever Switch
Signal Light
Terminal Block / Power Buzzer / Fuse Holder / Control Box

Proximity Sensor



■ CUP series Capacitive type proximity sensor

■ Specification

■ Capacitive DC 3 wire type

Model	NPN	CUP18R-8N□□	CUP18RP-8N□□	CUP30R-15N□□	CUP30RP-15N□□
	PNP	CUP18R-8P□□	CUP18RP-8P□□	CUP30R-15P□□	CUP30RP-15P□□
Appearance					
Shield	Non shield			Non shield	
Standard sensing object(mm)	Iron 50 X 50 X 1 (Grounded (earthed) state)				
Sensing distance	8 mm (Volume variation)			15 mm (Volume variation)	
Setting distance	0 ~ 6.4 mm			0 ~ 12 mm	
Hysteresis	Less than 20 % of sensing distance				
Response frequency	50Hz				
Power supply voltage	12 - 24 V d.c. (Usable voltage range 10 - 30 V d.c.)				
Control output	200 mA max (Resistive load)				
Residual voltage	Max 1.5 V				
Current consumption	Max 10 mA				
Operation indication	Red LED				
Protection circuit	Power reversely connected protective circuit, Surge protective circuit and Over current protective circuit are built in.				
Ambient temperature	-25 ~ 70 °C (Less than ±10 % of sensing distance at temperature 20 °C)				
Ambient humidity	35 ~ 85 %RH				
Insulation resistance	min 50 MΩ (500 V d.c. mega standard)				
Dielectric strength	For 1 min at 2,000 V a.c. 50/60 Hz (between the recharging part and case)				
Vibration resistance	10 - 55 Hz (cycle 1 min, double amplitude: 1.5 mm 2 hours for each of X, Y and Z directions)				
Shock resistance	500 % 3 times to each of X, Y and Z directions				
Degree of protection	IP67(IEC standard)				
Connection structure	Cable type (standard cable length 2 m), relay connector type, connector type				
Color	NPN : Green, PNP : Purple				
Material	CUP-18R/CUP-30R (Case: brass chrome plating, sensing surface: PBT resin), CUP-18RP/CUP-30RP (Case and sensing surface one body type: PBT resin)				

■ Capacitive type, DC/AC dual usage 2 wire type

Model	CUP18R-8F□□	CUP18RP-8F□□	CUP30R-15F□□	CUP30RP-15F□□	
Appearance					
Shield	Non shield			Non shield	
Standard sensing object(mm)	Iron 50 X 50 X 1 (Grounded (earthed) state)				
Sensing distance	8 mm (Volume variation)			15 mm (Volume variation)	
Setting distance	0 ~ 6.4 mm			0 ~ 12 mm	
Hysteresis	Less than 20% of sensing distance				
Response frequency	DC : 40 Hz / AC : 20 Hz				
Power supply voltage	20 - 240 V a.c./d.c. (Usable voltage range 18 - 250 V a.c./d.c.)				
Control output	5 - 250 mA max (Resistive load)				
Residual voltage	Max. 7 V (a.c./d.c.)				
Leakage current	Max 2 mA				
Operation indication	Red LED				
Protection circuit	Surge protective circuit built in.				
Ambient temperature	-25 ~ 70 °C (Less than ±10 % of sensing distance at temperature 20 °C)				
Ambient humidity	35 ~ 85 %RH				
Insulation resistance	min 50 MΩ (500 V d.c. mega standard)				
Dielectric strength	For 1 min at 2000 V a.c. 50/60 Hz (between the recharging part and case)				
Vibration resistance	10 - 55 Hz (cycle 1 min, double amplitude: 1.5 mm 2 hours for each of X, Y and Z directions)				
Shock resistance	500 % 3 times to each of X, Y and Z directions				
Degree of protection	IP67(IEC standard)				
Connection structure	Cable type (standard cable length 2 m), relay connector type, connector type				
Case	Brass (Chrome plating)	PTB resin	Brass (Chrome plating)	PTB resin	
Color	NO : Green, NC : Purple	NO/NC : Green	NO : Green, NC : Purple	NO/NC : Green	
Material	CUP-18R/CUP-30R (Case : brass chrome plating, sensing surface: PBT resin), CUP-18RP/CUP-30RP (Case and sensing surface one body type : PBT resin)				

Proximity Sensor

Suffix code

Model	Code	Information
CUP	□ □ - □ □ □ □	Capacitive type proximity sensor
Sensing area size	18	M18
	30	M30
Structure type	R	Round type (Brass chrome plating case)
	RP	Round type (Plastic case)
Sensing distance	8	8 mm(Only with CUP-18□-8)
	15	15 mm(Only with CUP-30□-15)
Power and output type	N	DC NPN output
	P	DC PNP output
	F	AC/DC 2 wire type (dual usage) (No polarity)
Output state	A	Normal Open (NO)
	C	Normal Close (NC)
Connection structure	*	Cable type
	CR	Relay connector type

Connector cable

Specification

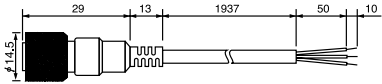
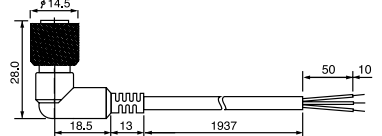
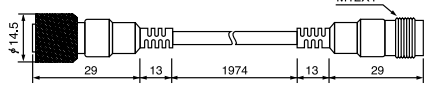
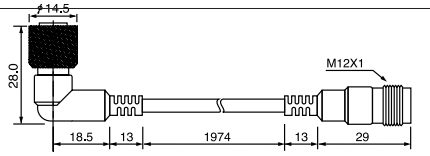
Type	Code	Power/Number of wire	Dimension	
Connector cable	AD3S	DC 3 wire	·Straight type 	
	AD2S	DC 2 wire		
	AA2S	AC 2 wire		
	AD3A	DC 3 wire	·Angle type 	
		AD2A		DC 2 wire
		AA2A		AC 2 wire
Relay cable	BD4S	DC 4 wire	·Straight type 	
	BA4S	AC 4 wire		
	BD4A	DC 4 wire	·Angle type 	
		BA4A		AC 4 wire



Suffix code

Model	Code	Information
	□ □ □ □ □	Cable for connecting proximity sensor
Cable	A	Connector cable
	B	Relay cable
Power supply voltage	A	AC
	D	DC
Sensing distance	2	2 wires
	3	3 wires
	4	4 wires
Power and output type	S	Straight type
	A	Angle type
Output state	2M	2 m
	5M	5 m

Photo Sensor

PZ1 series Mini photo sensor

Specification

		PZ series					
Appearance							
Type		Through beam			Diffuse reflection		
Model	NPN type	PZ1-T1N	PZ1-T5N	PZ1-T7N	PZ1-R10N	PZ1-R30N	PZ1-R40N
Sensing distance		1 m	5 m	7 m	100 mm	30-300 mm	40-400 mm
Detecting object		Opaque object of Min. Ø6 mm			White no-glossy paper 200×200 mm		
Power voltage		12 - 24 V d.c. (±10 %)					
Current consumption	Trns	Max. 20 mA d.c.			Max. 30 mA d.c.		
	Rcvr	Max. 18 mA d.c.					
Operating mode		LIGHT ON(L.ON) / DARK ON(D.ON) Selectable S/W build in type.					
Control Output		NPN/PNP OPEN collector output , Load current : Max.100 mA d.c. (Resistive load), Residual voltage : Max.1 V d.c.					
Response time		Max. 1 ms					
Hysteresis		-			Within 25 % of Operating distance	Within 10 % of Operating distance	Within 10 % of Operating distance
Light source		Infrared emitting diode					
Material		CASE : PC(EXRL)			Lense : PC		
Protection circuit		Reverse polarity protection and overcurrent protection					
Connection		3P (Trsn. 2P), Ø 3.8 mm, length : 2 m					
Ambient light		Sunlight : Max. 11,000 lx, Incandescent lamp : Max.3,000 lx					
Ambient temperature		Operating : -20 ~ 60 °C, Preserving : - 25 ~ 70 °C(Without condensation)					
Ambient humidity		Max. 35 ~ 85 % R.H.					
Protection structure		IP 65(IEC) (IP67 is an option)					
Vibration resistance		10 - 55 Hz (for a minute), double amplitude width : 1.5 mm, each X,Y,Z direction for 2hr.					
Dielectric strength		1000 V a.c. (50-60 Hz for a minute)					
Shock resistance		500 % (Approx 50 G), each X,Y,Z direction for 3times					
Insulation resistance		20 MΩ min.(At 500 V d.c. between code and case, adjusting switch and case)					
Weight		Trns., Rcvr. : each approx. 55 g			approx. 60 g		

Suffix code

Model	Code	Information	
PZ1-	<input type="checkbox"/> <input type="checkbox"/> <input type="checkbox"/>	Small size photo sensor	
Sensing method and sensing distance	T	1	1 m
		5	5 m
		7	7 m
	R	10	100 mm
		30	30 - 300 mm
		40	40 - 400 mm
Output	N	NPN open collector output	
	P	PNP open collector output	
Protective structure (cautious 1)		IP 65 : Standard type	
		IP 67 : Optional (No volume & setting switch)	

Photo Sensor

PS series Compact photo sensor with high accuracy

Specification

		PS series									
Appearance											
Type		Through beam			Retroreflection	Diffuse reflection			Distance convergent beam		
Model	NPN	PS-T1N	PS-T7N	PS-T10RN	PS-M2RN	PS-R7N	PS-R30N	PS-R40RN	PS-D3RN	PS-D4RN	PS-D5RN
	PNP	PS-T1P	PS-T7P	PS-T10RP	PS-M2RP	PS-R7P	PS-R30P	PS-R40RP	PZS-D3RP	PS-D4RP	PS-D5RP
Sensing distance		1 m	7 m	10 m	0.1-2 m	70 m	300 mm	400 mm	10-30 mm	10-40 mm	10-50 mm
Detecting object		ø6 mm			ø20 mm	white no-glossy paper 100×100 mm	white no-glossy paper 200×200 mm		White no-glossy paper 50×50 mm		
Power voltage		12 - 24 V d.c. ±10 % (Ripple ±10 %)									
Current consumption	Trns	Max. 23 mA	Max. 20 mA	Max. 23 mA	Max. 23 mA	Max. 28 mA	Max. 23 mA	Max. 25 mA	Max. 30 mA		
	Rcvr	Max. 20 mA	Max. 20 mA	Max. 20 mA							
Output	Control output	NPN / PNP open collector output, load voltage : Max. 30 V d.c., Resistive load : 100 mA, Inductive load : Max. 50 mA, Residual voltage : Max.1 V									
	Stability output	NPN open collector output, load voltage : Max. 30 V d.c., Resistive load : Max. 50 mA, Residual voltage : Max.1 V									
Operating mode		Light On / Dark On selection by switch Volume built-in type									
Response time		Max. 0.7 ms									
Hysteresis		-			Within 20 % of operating distance			Within 10 % of operating distance			
Light source		Infrared emitting diode		Red emitting diode		Infrared emitting diode		Red emitting diode			
Operating indicator		Control output indicator : Red LED, stability output indicator : Green LED(Infrared LED of emitting part for through beam type is power indicator)									
Ambient light		Sunlight : Max. 5000 lx									
Ambient temperature		-20 ~ 60 °C / -25 ~ 70 °C (No condensation)									
Ambient humidity		35 ~ 85 % RH (No condensation)									
Case protection		IP67(IEC)									
Vibration resistance		10 - 55 Hz (Cycle for 1 min.), Double amplitude : 1.5 mm, each X-Y-Z direction for 2 hr.									
Shock resistance		500 %g (approx. 50 G), each X-Y-Z direction for 3 time									
Connection		Flying lead NPN 4P(Trns, 2P) / PNP 3P(Trns 2P), ø3 mm, length 2 m					Flying lead NPN 4P / PNP 3P, ø3 mm, length 2 m				
Material		CASE : PC, Lens Cover : PC									
Weight		Trns-Rcvr:each 50 g(Net weight)				Approx. 50 g (Net weight)					

Suffix code

Model	Code	Information		
PS-	<input type="checkbox"/> <input type="checkbox"/> <input type="checkbox"/>	Small size photo sensor		
Sensing method and sensing distance	T	1	1 m	Through-beam
		7	7 m	
		10R	10 m	
	M	2R	0.1 - 2 m	Retro-reflective
		R	7	70 mm
	30		300 mm	
	40R		400 mm	
	D	3R	10 - 30 mm	Distance-settable
		4R	10 - 40 mm	
		5R	10 - 50 mm	
Output	N	NPN open collector output		
	P	PNP open collector output		

Photo Sensor

PW series Compact photo sensor with distance setting

Specification

Appearance		PW series			
					
Type		Diffuse reflection			
Model	NPN type	PW-D10RN	PW-D10N	PW-D15N	PW-D20N
	PNP type	PW-D10RP	PW-D10P	PW-D15P	PW-D20P
Sensing distance		10 – 100 mm	10 – 100 mm	10 – 150 mm	10 – 200 mm
Detecting object		White no-glossy paper 100×100 mm			
Power voltage		12 – 24 V d.c. ±10 % (Ripple ±10 % (Max.))			
Current consumption		Max. 30 mA			
Output	Control output	NPN open collector output(NPN TYPE)/PNP open collector output(PNP TYPE), Load Current:Max. 100 mA, Load voltage:Max. 30 V d.c.			
	Stabilize output	NPN open collector output Load Current:Max. 50 mA, Load voltage:Max. 30 V d.c. but there is no stable output with PNP output type			
Operating mode		Light ON / Dark ON Selectable			
Response time		Max. 0,7 ms			
Hysteresis		10 % of operating distance			
Light source		Red LED	Infrared emitting diode		
Operating Indicator		Control output indicate : Red LED, Stabilized output indicate : Green LED			
Ambient light		Sunlight : Max. 5000 lx			
Ambient temperature		-20 ~ 60 °C (Surrounding storage temperature : -25~70 °C) (Without condensation)			
Ambient humidity		35 ~ 85 % RH (Without condensation)			
Case Protection		IP67(IEC)			
Vibration resistance		10 – 55 Hz for 1 minute, Double amplitude width : 1,5 mm, X-Y-Z each direction for 2 hours			
Shock resistance		500 ٪ (About 50 G), X-Y-Z each direction for 10 times			
Connection		NPN type : Ø4/4C(Length : 2 m), PNP type : Ø4/3C(Length : 2 m)			
Material		CASE : Heatproof ABS, Lens Cover : PC(Translucent red)			
Weight		Approx. 80 g			

Suffix code

Model	Code	Information
PW –	<input type="checkbox"/> <input type="checkbox"/> <input type="checkbox"/> <input type="checkbox"/>	Photo Sensor Small Wide Type
Detection	D	Distance Convergent Beam Type
Sensing distance	10	10 ~ 100 mm
	15	10 ~ 150 mm
	20	10 ~ 200 mm
LED indicator	–	Infrared LED
	R	Red LED
Output	N	NPN output
	P	PNP output

■ PY series Mini flat type photo sensor

■ Specification

PY series									
Appearance									
Type	Through beam								
Model	PY-T3N								
	PY-T3P								
	<table border="1"> <tr> <td>PY-T3N-D</td> <td>PY-T3N-L</td> <td>PY-T3P-D</td> <td>PY-T3P-L</td> </tr> <tr> <td>PY-TL3(Trns.), PY-TR3N-D(Rcvr.)</td> <td>PY-TL3(Trns.), PY-TR3N-L(Rcvr.)</td> <td>PY-TL3(Trns.), PY-TR3P-D(Rcvr.)</td> <td>PY-TL3(Trns.), PY-TR3P-L(Rcvr.)</td> </tr> </table>	PY-T3N-D	PY-T3N-L	PY-T3P-D	PY-T3P-L	PY-TL3(Trns.), PY-TR3N-D(Rcvr.)	PY-TL3(Trns.), PY-TR3N-L(Rcvr.)	PY-TL3(Trns.), PY-TR3P-D(Rcvr.)	PY-TL3(Trns.), PY-TR3P-L(Rcvr.)
PY-T3N-D	PY-T3N-L	PY-T3P-D	PY-T3P-L						
PY-TL3(Trns.), PY-TR3N-D(Rcvr.)	PY-TL3(Trns.), PY-TR3N-L(Rcvr.)	PY-TL3(Trns.), PY-TR3P-D(Rcvr.)	PY-TL3(Trns.), PY-TR3P-L(Rcvr.)						
Detecting object	Opaque object of over (Min. Ø5 mm)								
Operating mode	Dark ON								
Sensing distance	3 m								
Response time	Max, 1 ms								
Power voltage	+12 ~ + 24 V d.c. ±10 % (Ripple Max. ±10 %)								
Current consumption	In case of rating Voltage 24 V d.c., Trns : 23 mA, Rcvr : Max, 18 mA								
Light source	Infrared emitting diode								
Control Output	<ul style="list-style-type: none"> • Load voltage : Max, 30 V d.c. • Stability output current : Max, 50 mA • Residual voltage : Max.1 V • NPN open collector output • load current : Max, 100 mA 								
Protection circuit	Reverse polarity protection, overcurrent protection								
LED Indicator	Trns. : Power indicate(Red LED), Rcvr. : Operating indicate(Red LED), Stability indicate(Green LED)								
Insulation resistance	Min. 20 MΩ (At 500 V d.c.)								
Dielectric strength	1000 V a.c. (for a minute in 50/60 Hz mega)								
Vibration resistance	10 ~ 55 Hz (cycle for 1 minute) double amplitude width : 1.5 mm, each X-Y-Z direction 2 hrs								
Shock resistance	500 % (Approx. 50 G) each X-Y-Z direction 2 time								
Ambient light	Sunlight : Max, 11000 lx, Incandescent : Max, 3000 lx								
Ambient temperature	-20 ~ 60 °C (Surrounding storage temperature : -25~70 °C) (Without condensation)								
Ambient humidity	35 ~ 85 % R,H								
Case Protection	IP 67 (IEC)								
Material	Lens, case : PC								
Connection	Trns. : Ø3 mm, 2P, Rcvr. : Ø3 mm, 3P(NPN:4P), Cable length : 2 m								
Weight	Approx. 66 g								



■ Suffix code

Model	Code	Information
PY -	<input type="checkbox"/> <input type="checkbox"/> <input type="checkbox"/> <input type="checkbox"/>	Slim type Photo Sensor
Detection	D	Through beam
Sensing distance	3	3 m
Output	N	NPN Open Collector Output
	P	PNP Open Collector Output
Operation	D	Dark ON Operation
	L	Light ON Operation

Photo Sensor

■ PN series Voltage output type photo sensor

■ Specification

Model	PN-T3	PN-R02	PN-M1
Appearance			
Type	Through beam	Diffuse reflection	Retroreflection
Sensing distance	3 m	200 mm	0.1–1 m
Detecting object	Substance (over Ø8 mm)	White no-glossy (200 x 200 mm)	Substance (over Ø48 mm)
Power voltage	12 – 24 V d.c.(± 10 %)		
Current consumption	Emitter : Max. 2.0mA d.c., Receiver : Max. 18 mA d.c.	Max. 30 mA d.c.	
Operating mode	Dark : ON	Light : ON	Dark : ON
Control Output	NPN voltage output :Load voltage Max. 30 V d.c., Load current : Max 200 mA , Residual voltage: Max. 1 V		
Protection circuit	Reverse polarity protection, Overcurrent protection		
Response time	Max. 3 ms		
Hysteresis	–	Max. 20 %	–
Light source	Infrared LED (Modulated)		
Sensitivity control	–	By sensitivity control volume	–
Material	Case	Polycarbonate	
	Lens	Polycarbonate	
Connection	Cable		
Ambient light	Sun light : Max. 11,000 lx, Incandescent light : Max. 3,000 lx		
Ambient temperature	–25 ~ 55 °C (Surrounding storage temperature : –40~70 °C) (Without condensation)		
Ambient humidity	35 ~ 85 % RH (Without condensation)		
Case protection	IP54(IEC)		
Vibration resistance	10 – 55 Hz, Double amplitude 1.5 mm, X:Y:Z each direction for 2 hours		
Dielectric strength	1,000 V a.c. for 1 minute		
Insulation resistance	Min. 20 MΩ (At 500 V d.c., Between code and case, contact and power supply)		
Accessories	Bracket for fixing, Bolt, Nut for fixing		

(Note 1) The sensing distance can be varied depending on the size, surface condition, glossy, non-glossy of the sensing object

(Note 2) PN-TL3 is transmitter and PN-TR3 is receiver when it is through beam type

■ Suffix code

Model	Code	Information
PN –	<input type="checkbox"/> <input type="checkbox"/>	Photo Sensor
Detection	T 3	Through beam
	M 1	Diffuse reflection
	R 02	Retroreflection
Operation		12 – 24 V d.c. ± 10 %

PR series Simple installing cylinder type photo sensor

Specification

Model	Brass case	PR-T10NC	PR-M1NC	PR-M2NC	PR-R100NC	PR-R300NC
	Plastic	PR-T10NP	PR-M1NP	PR-M2NP	PR-R100NP	PR-R300NP
Appearance						
Sensing method	Through beam type		Retroreflection type		Diffuse reflection type	
Sensing distance	10 m		1 m	2 m	100 mm	300 mm
Detecting object	Min Ø10 mm (Opaque above)		Min Ø25 mm (Opaque above)		200 x 200 mm White non-glossy paper	
Power supply voltage	12 – 24 V d.c. ±10 %					
Current consumption	Transmitter	Max. 20 mA		Max. 35 mA		
	Receiver	Max. 15 mA				
Control output	NPN voltage output, Load current max 200 mA (30 V d.c.), Resistive load					
Output action	L,ON, D,ON * Selected by the control line, but limited with receiver in the through beam type					
Response time	max 1.5 ms					
Hysteresis	–				Less than ±20 % of the sensing range	
Light source(Wave length)	Infrared lightening LED (890 nm)					
LED	Control output indicator: Red LED (Red LED of through beam type transmitter is the power indicator)					
Sensitivity adjustment	By the sensitivity adjusting volume (But limited with the receiver in the through beam type)					
Protection circuit	Reverse polarity protection and output short-circuit protection					
Ambient illumination	Sunlight: max 11,000 Lux, Incandescent lamp : max 3,000 Lux					
Ambient temperature	–20 ~ 60 °C (Surrounding storage temperature : –25 ~ 70 °C) (Without condensation)					
Ambient humidity	35 ~ 85 % RH (With no condensation)					
Protective structure	IP 66 (IEC)					
Insulation resistance	min 20 MΩ (500 V d.c., Between the code and case)					
Dielectric strength	1,000 V a.c., 50/60 Hz for 1 min					
Vibration resistance	10 – 55 Hz double amplitude 1.5mm, for 2 hours each in X, Y and Z directions					
Shock resistance	500 %, 3 times each in X, Y and Z directions					
Connection method	Code extended type 2 m, 4P (Transmitter of the through beam type : 3P)					
Material	Case : brass (Nickel plating) / PBT, lens : PC					
Weight	Brass case : Approx. 120 g, Plastic case : Approx. 100 g					

(Note 1) The sensing distance can be varied depending on the size, surface condition, glossy, non-glossy of the sensing object

(Note 2) PR-TL10N□ is transmitter and PR-TR10N□ is receiver

(Note 3) Sensing range of the retroreflection type is a distance when using HY-M5 (Mirror)





Suffix code

Model	Code	Information
PR	□ □ □ □	Round type photosensor
Sensing method and Sensing distance	T 10	Through-beam 10 m
	M 1 2	Retro-reflection 1 m 2 m
	Output	N PNP open collector output
	P PNP open collector output	
material	P	Plastic case
	C	Brass case

Photo Sensor

■ PU series Fast responding, Best reliability

Specification

Model	PU-30	PU-30S	PU-50	PU-50S
Appearance				
Sensing distance	30 mm		50 mm	
Detecting object	Over Ø2 mm(Substance)	Over Ø0.6 mm (Substance)	Over Ø1.5 mm (Substance)	Over Ø0.4 mm (substance)
Power voltage	12 – 24 V d.c. ±10 %			
Current consumption	Max. 30 mA			
Operating mode	Selectable Light On/Dark On for reverse polarity			
Control Output	NPN Open collector output : Load voltage Max. 300 V d.c., Load current : Max, 180 mA, Residual voltage : Max, 2 V			
Protection circuit	Reverse polarity protection , Overcurrent protection			
Response time	Max,1 ms			
Light source	Infrared LED (Modulated)			
LED Indicators	Output : Red LED, Power : Green LED			
Sensitivity adjustment	–	By adjusting volume	–	By adjusting volume
Material	Case	Zn		
	Lens	Polycarbonate		
Connection	Cable			
Ambient light	Sun light : Max, 11,000 lx, Incandescence light : Max 3,000 lx			
Ambient temperature	–25 ~ 55 °C (Surrounding storage temperature : –40~70 °C) (Without condensation)			
Ambient humidity	35 ~ 85 % RH (Without condensation)			
Case protection	IP65(IEC)			
Vibration resistance	10 – 55Hz, Double amplitude 1.5 mm, X:Y:Z each direction for 2 hours			
Dielectric strength	1,000 V a.c. for 1minute			
Insulation resistance	Min, 20 MΩ (At 500 V d.c., Between code and case, contact and power supply)			

PTX series Photo sensor

Specification

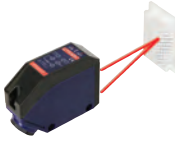
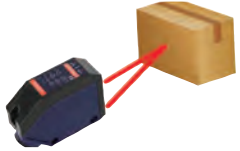
Model	Type	Normal Type	Timer Built-in Type	Normal Type	Timer Built-in Type	Normal Type	Timer Built-in Type
		Built in Power Supply	PTX-T15A	PTX-T15A-T	PTX-M7A	PTX-M7A-T	PTX-R1A
	Built in Amplifier	PTX-T15B	PTX-T15B-T	PTX-M7B	PTX-M7B-T	PTX-R1B	PTX-R1B-T
Appearance							
Sensing Type		Through beam		Retroreflection		Diffuse reflection	
Sensing distance		15 m		7 m		1 m	
Detecting object		More than Ø20 mm (Opaque object)		More than Ø60 mm (Opaque object)		200 x 200 mm (White no glossy paper)	
Power voltage	Built in Power Supply	24 – 240 V a.c./d.c. ±10 % 50/60 Hz					
	Built in Amplifier	12 – 24 V d.c. (± 10 %)					
Current Consumption	Emitter	Max 2 W		Max 2 W			
	Transmitter	Max 1 W					
Control Output	Built in Power Supply	Relay contact output (Contact composition 1a, 1b), Contact capacity : 5A resistive load, rated load life expectancy less than 100,000 times.					
	Built in Amplifier	NPN/PNP open collector yield output at the same time, Load : 150 mA, Load current: (Resistive load) NPN Residual voltage: Max 1 V d.c./PNP Residual voltage: Max 2 V d.c.					
Operation mode		Light ON/Dark ON are selectable by the selector switch					
Response time	Built in Power Supply	Max 20 ms					
	Built in Amplifier	Max 1 ms					
Hysteresis		-		Less than 20 % of sensing distance			
Light source		Output indication: Red LED, Stability indication: Green LED					
Sensitivity adjustment		Sensitivity adjusting volume built-in					
Protection circuit	Built in Power Supply	Surge protection					
	Built in Amplifier	Reverse polarity protection and output-circuit protection					
Timer function built-in (Only corresponds to timer built-in type)		Select OFF Delay, ON Delay or One Shot Delay by using the ON/OFF switch. Delay Time: 0.1~5sec adjust by the volume.					
Ambient illumination		Sun light: Max 11,000 lx, Incandescent lamp: Max 3,000 lx					
Ambient temperature		Operation temperature : -20 ~ 60 °C, Storage temperature : -25 ~ 70 °C(with no icing nor dew condensation)					
Ambient humidity		35 ~ 85 % RH (with no icing nor dew condensation)					
Degree of protection		IP66 (IEC standard)					
Insulation resistance		Min 20MΩ (standard on 500 V d.c. mega)					
Dielectric strength		1,500 V a.c. (for 1min)					
Vibration resistance		10 – 55 Hz Double amplitude: 1.5 mm, 2 hours to each of X, Y, Z directions					
Shock resistance		500 % (approx 50G), 3 times to each of X, Y, Z directions					
Connection method		Terminal					
Material		Case : ABS, Lens : PC					
Weight		Max 80g					
Accessories	Individual	-		Reflector		-	
	Common	Driver, Bracket, Bolt, Nut, Water-proof rubber, Wire holder					

Note1) The sensing distance may vary depending on the size, surface condition, glossy, non-glossy of the sensing object

Note2) The sensing distance of PTX-M7A (-T), PTX-M7B (-T) is the distance when using the reflector HY-M5

Suffix code

Model	Code	Information
PTX --	<input type="checkbox"/> <input type="checkbox"/> <input type="checkbox"/> <input type="checkbox"/>	Photo Sensor
Sensing method and Sensing distance	T 15	Through-beam 15m
	M 7	Retro-reflection 7m
	R 1	Diffuse reflection 1m
Power supply voltage	A	24 – 240 V a.c./d.c. ±10 % 50/60 Hz
	B	12 – 24 V d.c. ±10 %
Timer	-	Normal type
	-T	Timer Built-in type

Temperature Controller
Recorder
Digital Counter
Timer
Analog
Timer
Panel Meter
Multi Pulse Meter
Proximity Sensor
Photo Sensor
Rotary Encoder
Thyristor Power Regulator
Solid State Relay
Power Supply
Control Switch
Push Button / Main Switch
Cam Switch / Limit Switch
Micro / Hoist Switch
Foot / Mono Lever Switch
Signal Light
Terminal Block / Power Buzzer / Fuse Holder / Control Box

Photo Sensor

■ PL-D2B Photo sensor

Specification

Model	PL-D2B
Appearance	
Sensing method	Distance-settable
Sensing distance	0.2 ~ 2 m
Detecting object	200 X 200 mm White paper with no gloss
Power supply voltage	12 - 24 V d.c. ±10 %
Current consumption	30 mA max.
Control output	NPN / PNP open collector asynchronously, Load current : 150 mA d.c. max. (Resistive load) NPN remaining voltage : 1 V d.c. max., PNP remaining voltage Max : 2 V d.c.
Operation mode	Light ON / Dark ON ※ Selectable by the mode V/R
Response time	2 ms max.
Hysteresis	Less than 10% of the sensing distance
Light source(Wave length)	Infrared lightening LED (880 nm)
Receiving part	2 photo diodes
Display	Control out display: Red LED, Stability display: Green LED
Distance setting	Near/Far: Optical distance adjusting volume 5 cycles.
Protection circuit	Reverse polarity protection and output short-circuit protection
Ambient illumination	Sunlight : 11,000 lx max., Incandescent lamp : 3,000 lx max.
Ambient temperature	Operation : -20 ~ 60 °C, Storage : -25 ~ 70 °C (Without freezing)
Ambient humidity	35 ~ 85 % RH (Without condensation)
Protective structure	IP 65
Insulation resistance	20 MΩ min.(500 V d.c. Mega)
Dielectric strength	1000 V a.c. (50/60 Hz for 1 min)
Vibration resistance	10 - 55 Hz, double amplitude :1.5mm for 2 hours each in X, Y and Z directions.
Shock resistance	500 %g 3 times each in X, Y and Z directions.
Connection method	Cable output type, Number of wires: 4P, Thickness:Ø 4mm, Length 2m
Material	Case : PC, Lens : PC
Accessory	Bracket, Adjustable driver, bolt, Nut.



Suffix code

Model	Code	Information
PL -	D 2 B	Photosensor
Sensing method	D	Distance-settable
Sensing distance	2	2 m
Power supply voltage	B	12 - 24 V d.c.

Photo Sensor

■ PEN series Photo sensor

■ Specification

Model	PEN-T10A	PEN-M5A	PEN-R700A
Appearance			
Type	Through beam	Retroreflection	Diffuse reflection
Sensing distance	10 m	0.1 ~ 5 m	700 m
Detecting object	More than $\varnothing 16$ mm (Opaque object)	More than $\varnothing 60$ mm (Opaque object)	200 x 200 mm (White no glossy paper)
Power voltage	24 – 240 V a.c./d.c. 50/60 Hz ± 10 %		
Current Consumption	Trns	Max. 1 W	Max. 2 W
	Rcvr	Max. 2 W	
Control Output	Relay output (Contact composition 1a,1b) capacity : 30 V d.c. 5 A / 250 V a.c. 5 A Resistance load life expectancy – min 100 thousand time		
Operation mode	Light ON / Dark ON		
Response time	Less than 20 ms		
Hysteresis	–		Within 20 % of detecting distance
Light source	Infrared LED		
Protection circuit	Reverse polarity protection and overcurrent protection		
Connection	Length of code : 1.5 M 5P $\varnothing 6$ mm, Trns : 2P (Built in power supply : 4P $\varnothing 4$ mm, Trns : 2P)		
Ambient light	Sun light: less than 11,000 lx, Incandescent lamp: less than 3,000 lx		
Ambient temperature	Operation : $-20 \sim 60$ °C (Storage : $-25 \sim 70$ °C)		
Protection	IP64(IEC)		
Vibration resistance	10 – 55 Hz, Double amplitude width 1.5 mm , X·Y·Z, each direction for 2 hours		
Dielectric strength	1,500 V a.c. (1 minute)		
Insulation resistance	500 %, X.Y.Z each direction 3 times		
Material	Case : Heatproof ABS, Lens : PC		
Insulation resistance	More than 20 M Ω (At 500V d.c. between code and case, adjusting switch and case)		
Weight	150 g (Built in Power Supply), 100 g (Built in Amplifier)		



■ Suffix code

Model	Code	Information
PEN –	<input type="checkbox"/> <input type="checkbox"/> <input type="checkbox"/>	Photo Sensor
Sensing method and Sensing distance	T 10	Through-beam 10 m
	M 5	Retro-reflection 0,1 – 5 m
	R 700	Diffuse reflection 700 mm
Power supply voltage	A	24 – 240 V a.c./d.c. 50/60 Hz ± 10 %
	B	12 – 24 V d.c. ± 10 %

Photo Sensor

■ PE series Power built-in photo sensor

■ Specification

MODEL	PE-T5D	PE-R05D	PE-M3D
Appearance			
Type	Through beam	Diffuse reflection	Retroreflection
Sensing distance	5 m	500 m	0,1m – 3 m
Detecting object	Substance(over 20 mm)	White no-glossy paper (500x500 mm)	Substance(over Ø60 mm)
Power voltage	24 – 240 V a.c. (50/60 Hz) / 24 – 240 V d.c.		
Current Consumption	Trns : Max. 0.7 W Rcvr : Max. 1.2 W	Max. 2 W	Max. 1.6 W
Operation mode	Dark : ON	Light : ON	Dark : ON
Control Output	Relay output 1c 250 V a.c. 2 A(Resistive load)		
Response time	Max. 25 ms		
Hysteresis	–	Max. 20 %	–
Light source	Infrared LED(Modulated)		
LED Indicators	Power ON / OFF	Operation Indicating	
Sensitivity control	–	By sensitivity control volume	
Material	Polycarbonate		
Connection	Cable		
Ambient light	Max. 20,000 lx		
Ambient temperature and humidity	Max. –20 °C ~ 60 °C, 85 % RH		
Case protection	IP54(IEC)		
Vibration resistance	10 – 55 Hz, Double amplitude width 1.5 mm , X-Y-Z, each direction for 2 hours		
Dielectric strength	1,500 V a.c. for 1 minute		
Insulation resistance	Min. 20 MΩ (At 500 V d.c., Between code and case, contact and power supply)		
Accessories	Bracket for fixing, Bolt Nut for fixing		

Temperature
Controller

Recorder

Digital
Counter
Timer

Analog
Timer

Panel
Meter

Multi Pulse
Meter

Proximity
Sensor

Photo
Sensor

Rotary
Encoder

Thyristor
Power
Regulator

Solid
State
Relay

Power
Supply

Control
Switch

Push Button /
Main
Switch

Cam Switch /
Limit
Switch

Micro /
Hoist
Switch

Foot /
Mono Lever
Switch



Signal
Light

Terminal Block /
Power Buzzer /
Fuse Holder /
Control Box

Photo Sensor

PG series Fiber optic sensor

Specification



		Universal type	Multi type(Stable output)
Appearance			
Model	NPN	PG-TRN	PG-TARN
	PNP	PG-TRP	PG-TARP
Function		Change OFF Delay, ON Delay by switch Delay Time : 40 ms	Change OFF Delay, ON Delay, One Shot Delay by switch Delay Time : 0.1 ~ 5 sec. (adjustable by volume)
Sensing method		Through beam type, Diffuse reflection type(Decision by combined with Fiber unit)	
Sensing distance		Decision by combined with Fiber unit	
Power supply voltage		12 - 24 V d.c. ±10 %	
Current consumption		Max. 35 mA	
Output	Control	NPN/PNP Voltage output , Load voltage : Max. 200 mA(30 V d.c.), Residual voltage : Max. 1 V d.c.	
	Stability	-	NPN/PNP Voltage output Load voltage : Max. 50 mA(30 V d.c.) Residual voltage : Max. 1 V d.c.
Operation mode		Light ON / Dark ON switch selection operating Normal or ON/OFF delay Switch selection operating	
Response time		Max. 1 ms	
Hysteresis		Max. 10 % of sensing distance (Reflection)	
Light source(wave length)		Red LED(630 nm)	
LED		Control output indicator : Red LED, Stability indicator : Green LED	
Sensitivity adjustment		Built in the sensitivity control V/R	
Protection circuit		Reverse polarity protection, overcurrent protection (except for stable output of multi-function type)	
Ambient illumination		Sunlight : Max. 11,000 lx, Incandescent lamp : Max. 3,000 lx	
Ambient temperature		Operating : -20 ~ 60 °C, preserving : -25 ~ 70 °C(Without condensation)	
Ambient humidity		35 ~ 85 % RH(Without condensation)	
Protective structure		IP40	
Insulating resistance		Min. 20 MΩ (500 V d.c. Mega standard)	
Dielectric strength		1000 V a.c. 50/60 Hz for 1 min	
Vibration resistance		10 - 55 Hz double amplitude 1.5mm, X,Y,Z each direction for 2 hours	
Shock resistance		500 % X,Y,Z each direction for 2 times	
Connection method		Cable extended type (Number of wire : 3P, Diameter ø4, Length 2 m)	Cable extended type (Number of wire : 4P, Diameter ø4, Length 2 m)
Weight		Approx. 120 g	

Suffix code

Model	Code	Information
PG -	<input type="checkbox"/> <input type="checkbox"/>	Fiber optic sensor
Sensing method and Sensing distance	TR	Universal type
	TAR	Multi type (stable output)
Output	N	NPN open collector output
	P	PNP open collector output

■ PFD series Digital Multi Control Type

■ Specification

		Digital Multi Control Type	
Appearance		 	
Type		General purpose	Multi function
Model	NPN	PFD-RGN	PFD-RMN
	PNP	PFD-RGP	PFD-RMP
Power voltage		12 – 24 V d.c. ±10 % (Ripple Max. 10 %)	
Current consumption		Max. 30 mA	
Output	Control	Open collector output, 100 mA (Supplied voltage Max. 30 V, Residual voltage Max. 0.5 V)	
	Stability	Open collector output, 100 mA (Supplied voltage Max. 30 V, Residual voltage Max 0.5 V)	
External input		Teaching / Auto teaching	Teaching / Auto teaching / Reset input
Operating mode		Light On / Dark On output Normal output, ON DELAY, OFF DELAY, ON/OFF DELAY output	
On/Off Delay		0 ~ 9999 ms	
Light source		Red emitting diode / 660 nm	
Protection circuit		Reverse polarity protection, Overcurrent protection	
Response time		Max. 700 μs	
LED indicator		7 points status LED, 4 Digits FND	
Sensitivity control		Auto-teaching, Manual	
Additional function		Brightness control 180 ° Turning indication Display time set, Zero Reset, Initial reset, Lock function	
Ambient light		Incandescent Light : Max. 10,000 lx	
Ambient temperature		Operating : -20 ~ 60 °C, preserving : -25 ~ 70 °C (Without condensation)	
Ambient humidity		35 ~ 85 % RH	
Vibration resistance		10 – 55 Hz for 1 minute, Double amplitude : 1.5 mm, X·Y·Z each direction for 2 hours	
Shock resistance		1,000 % (About 50 G), X·Y·Z each direction for 3 times	
Dielectric strength		1500 V a.c. 50/60 Hz for 1 minute	
Insulation Resistance		Min. 20 MΩ (at 500 V d.c.)	
Connection		For DIN Rail attachment Flying lead 1.5 m 5 P	

·MODEL : PFD-RMN only

Multi function	Counter	<ul style="list-style-type: none"> • UP / DOWN Mode, Prescale 1 ~ 1000 integers setting • Output mode : 8 kinds selectable (N, F, C, R, K, P, Q, A) 	<ul style="list-style-type: none"> • Indicating range : 0 ~ 9999 • External reset : Min. Signal width 5 ms 	<ul style="list-style-type: none"> • Counting speed : 400 cps
	RPM	<ul style="list-style-type: none"> • Indicating range : 0 ~ 9999 rpm 	<ul style="list-style-type: none"> • Speed monitoring output function 	<ul style="list-style-type: none"> • Prescale : 1~1000 integers setting • Measurement cycle setting
Option	Communication	RS485 or RS232 (TTL Level), No external output when using communication		

■ Suffix code

Model	Code	Information
PFD -	<input type="checkbox"/> : <input type="checkbox"/> <input type="checkbox"/>	10 bit A/D, 4Digit display
Light source	R	Red LED
Use	G	General purpose (MARK)
	M	Multi type (MARK / RPM / COUNTER)
External output	N	NPN Open collector
	P	PNP Open collector

Photo Sensor

■ PFB series Bar Indication Type

Specification

Appearance		Bar Indication Type
		
Type		General purpose
Model	NPN	PFB-RN
	PNP	PFB-RP
Power voltage		12 – 24 V d.c. ±10 % (Ripple Max. 10 %)
Current consumption		Max. 20 mA
Output	Control	Open collector output, 100 mA (Supplied voltage Max. 30 V, Residual voltage Max. 0.5 V)
	Stability	Open collector output, 100 mA (Supplied voltage Max. 30 V, Residual voltage Max. 0.5 V)
External input		Auto teaching
Operating mode		Normal output, ON DELAY, OFF DELAY output
On/Off Delay		10, 40 ms
Light source		Red emitting diode / 660 nm
Protection circuit		Reverse polarity protection, Overcurrent protection
Response time		1 ms
LED indicator		6 Points bar
Sensitivity control		Auto-teaching
Ambient light		Incandescent Light : Max. 11,000 / 3,000 lx
Ambient temperature		Operating : -20 ~ 60 °C, preserving : -25 ~ 70 °C (Without condensation)
Ambient humidity		35 ~ 85 % RH
Vibration resistance		10 – 55 Hz for 1 minute, Double amplitude : 1.5 mm, X-Y-Z each direction for 2 hours
Shock resistance		500 %g (About 50 G), X-Y-Z each direction for 3 times
Dielectric strength		1,000 V a.c. 50/60 Hz for 1 minute
Insulation Resistance		Min. 20 MΩ (at 500 V d.c.)
Connection		For DIN Rail attachment Flying lead 1.5 m 5 P

Suffix code

Model	Code	Information
PFB –	□ □	10 bit A/D, Bar display
Light source	R	Red LED
External output	N	NPN Open collector
	P	PNP Open collector

PAS series Area sensor

Specification

Model	NPN	PAS-T4N	PAS-T8N	PAS-T12N	PAS-T16N	PAS-T20N
	PNP	PAS-T4P	PAS-T8P	PAS-T12P	PAS-T16P	PAS-T20P
Appearance						
Type	Through beam					
Sensing distance	5 m					
Detecting object	Opaque object of Min. Ø30 mm					
Optical axis pitch	20 mm					
Number of optical axis	4	8	12	16	20	
Sensing range	60 mm	140 mm	220 mm	300 mm	380 mm	
Power voltage						
Current Consumption	Max. 80 mA	Max. 90 mA	Max. 100 mA	Max. 110 mA	Max. 120 mA	
Output range	NPN open collector output—Load current : Max. 100 mA, Load voltage : Max. 30 V d.c., Residual voltage : Max. 1 V PNP open collector output—Load current : Max. 100 mA, Output voltage : (Power voltage—over 2.5 V)					
Operating mode	Light ON					
Response time	Below 7 ms					
Light source	Infrared emitting diode(Wave length 850 nm)					
Point angle	Within ±5° (At over 2 m sensing distance)					
Operating indicator	Trns.:M/S display:Red LED, Power display : Green LED, Operation Display : Red LED Rcvr.E1 display : Red LED, E2 display : Blue, Red, Light on stability display : Green LED, Operation display : Red LED					
Ambient light	Sun light : 11,000 / 3,000 lx					
Ambient temperature	Operating : -20 ~ 60 °C, preserving : -25 ~ 70 °C (Without condensation)					
Ambient humidity	35 ~ 85 % RH					
Vibration resistance	0 - 55 Hz (Cycle for 1 min.) Double amplitude width 1.5 mm, each X:Y:Z direction for 2 hr.					
Case protection	IP40(IEC)					
Dielectric strength	1,000 V a.c. for 1 min. between current part and case					
Material	Case : ABS, Window : Acryl					
Connection	Flying lead 5P, Ø4.3 length 3 m					
Weight	Each Max.160 g	Each Max.180 g	Each Max.200 g	Each Max.220 g	Each Max.240 g	
Protection function/circuit	Auto sensitivity compensation, Mutual interference prevention in parallel installation (M/S mode), Reverse polarity protection, Overcurrent protection					

Suffix code

Model	Code	Information
PAS -	<input type="checkbox"/> <input type="checkbox"/> <input type="checkbox"/>	Area sensor
Sensing method	T	Through beam
Number of optical axis	4	4 optical axis
	8	8 optical axis
	12	12 optical axis
	16	16 optical axis
	20	20 optical axis
Control output	N	NPN open collector
	P	PNP open collector

Photo Sensor

PAN series High reliable optical area sensor with an exclusive IC

Specification

Model	PAN20-T□□N, PAN20-T□□P	PAN40-T□□N, PAN40-T□□P
Appearance		
Type	Through beam	
Sensing distance	7 m	
Detecting object	Opaque object of over Ø32 mm	Opaque object of over Ø52 mm
Optical axis pitch	20 mm	40 mm
Power voltage	12 – 24 V d.c. ±10 % (Ripple P–P ± 10 %)	
Current Consumption	Max. 170 mA	Max. 100 mA
Output Control	Light ON	
Operating mode	Trns./M/S display: Red LED, Power display : Green L(+) Rcvr. E1 display : Red LED, E2 display : Blue LED stability display : Green LED, Operation display : Red LED	
Response time	Max. 15 ms	Max. 7 ms
Light source	Infrared emitting diode (Wave length 880 nm)	
Operating indicator	Trns./M/S display: Red LED, Power display : LED, Operation Display : Red, Rcvr.: E1 display : Green LED, E2 display : Red, Light on stability display : Green LED, Operation display : Red LED	
Operating S/W	ALL/ONE S/W Operation (only for Rcvr.), Max./ter/Slave S/W Operation (only for Trns.)	
Ambient light	Sun light : Max. 11,000 / 3,000 lx	
Ambient temperature	Operating : –20 ~ 60 °C, preserving : –25 ~ 70 °C (Without condensation)	
Ambient humidity	Max. 35 ~ 85 % RH	
Vibration resistance	10 – 55 Hz (Cycle for 1 min.) Double amplitude width 1.5 mm, each X-Y-Z direction for 2 hr.	
Case protection	IP65 (IEC)	
Dielectric strength	1000 V a.c. for 1 min. between current part and case	
Material	Case: Aluminum, Window : acryl, Lens : acryl	
Connection	Connector flying lead 4P Ø5.5	
Protection function/circuit	Mutual interference prevention when parallel installation (M/S mode), Reverse polarity protection, Overcurrent protection	

Production formation

series	Model	Sensing Distance	Number of optical axis	Sensing range	Detecting object
PAN20	PAN20-T08	7 m	8EA	140 mm	Opaque object of over Ø32 mm
	PAN20-T12		12EA	220 mm	
	PAN20-T16		16EA	300 mm	
	PAN20-T20		20EA	380 mm	
	PAN20-T24		24EA	460 mm	
	PAN20-T28		28EA	540 mm	
	PAN20-T32		32EA	620 mm	
	PAN20-T36		36EA	700 mm	
	PAN20-T40		40EA	780 mm	
	PAN20-T44		44EA	860 mm	
PAN20-T48	48EA	940 mm			
PAN40	PAN40-T04	7 m	4EA	120 mm	Opaque object of over Ø57 mm
	PAN40-T06		6EA	200 mm	
	PAN40-T08		8EA	280 mm	
	PAN40-T10		10EA	360 mm	
	PAN40-T12		12EA	440 mm	
	PAN40-T14		14EA	520 mm	
	PAN40-T16		16EA	600 mm	
	PAN40-T18		18EA	680 mm	
	PAN40-T20		20EA	760 mm	
	PAN40-T22		22EA	840 mm	
PAN40-T24	24EA	920 mm			

Suffix code

Model	Code	Information
PAN-	□ □ □ □	Area sensor
Optical axis pitch	20	20 mm gap
	40	40 mm gap
Sensing method	T	Through beam
Number of optical axis	□	Number of optical axis (please refer to the dimension)
Output	N	NPN open collector
	P	PNP open collector

HPAN series Sensor controller

Specification

MODEL	HPAN-C7	HPAN-CT7	HPAN-C7W
Appearance	 <p>8,5(W) X 82,1(H) X 80,8(D)</p>		
Function	Multi-purpose	Timer function	Two sensors connectable
How to attach	DIN Rail		
Power Voltage	100 – 240 V a.c. 50/60 Hz		
Power consumption	Approx. 5 VA		
Power supply to sensor	+12 V d.c. (±10 %), Max. 200 mA		
Connectable sensor	NPN / PNP transistor output or relay output sensor		
Output	<ul style="list-style-type: none"> Relay contact : 1c (250 V a.c. 3 A, Resistive load) Rated electrical life : over 100,000 operation NPN Transistor output (open collector) Max. sink current : 100 mA, Applied voltage : 30 V d.c. Max. 		<ul style="list-style-type: none"> Relay contact:1c (2outs separately) (250 V a.c. 3A resistive load) Rated electrical life: over 100,000 operations (in power off)
Response time	Relay contact : Approx. 10 ms, Open collector : 5 μs Max.		Approx. 10 ms
External synchronization	Gate synchronization	Frequency and differential synchronization	–
Timer	–	<ul style="list-style-type: none"> Selectable from on-delay, off-delay and one shot-delay Time range 40 ms~1 S→ 0,4~10 S (selectable by dip switch) 	–
Ambient temperature and humidity	–25 ~ 70 °C, 35 – 85 % RH (without condensation)		
Noise immunity	Power line: 2,000 VP, 0,5 μs pulse width (by noise simulation)		
Dielectric strength	1,500 V a.c. for 1 minute (Between supply and output)		
Insulation resistance	20 MΩ (At 500 V d.c., Between supply and output)		
Vibration resistance	10 – 55 Hz(For a minute), double amplitude width 1.5 mm, each X-Y-Z direction for 2 hour (in power off)		
Shock resistance	100 ⅔ (Approx. 10 G), each X-Y-Z, 2 direction (in power off)		
Net-Weight	Approx. 150 g	Approx. 160 g	Approx. 165 g

HPA-12 Sensor controller



Specification

MODEL	HPA-12
Appearance	 <p>49(W) X 62(H) X 91(D)</p>
Function	Multi-purpose
How to attach	Relay Socket 8PIN
Power Voltage	220 V a.c. ±10 % 60 Hz
Power consumption	Approx. 4 VA
Power supply to sensor	12 V DC±10 % 50 mA
Connectable sensor	NPN, PNP transistor output
Output	Relay contact: 1c (250 V a.c. 3 A, resistive load) Rated electrical life: over 100,000 operations (in power off)
Response time	Approx. 10 ms
Ambient temperature and humidity	–20 ~ 60 °C, 25 ~ 70 % RH (No freezing or No condensation)
Noise immunity	Power line: 2,000 VP, 0,5 μs pulse width (by noise simulation)
Dielectric strength	1,500 V a.c. for 1 minute (Between supply and output)
Insulation resistance	20 MΩ (At 500 V d.c., Between supply and output)
Vibration resistance	10 – 55 Hz(For a minute), double amplitude width 1.5 mm, each X-Y-Z direction for 2 hour (in power off)
Shock resistance	100 ⅔ (Approx. 10 G), each X-Y-Z, 2 direction (in power off)
Net-Weight	Approx. 260 g

Rotary Encoder

HE30B, HE40B, HE50B series Shaft rotary encoder

Specification

MODEL		HE30B	HE40B	HE50B	
Appearance					
Electrical specification	Phase difference on output	Phase difference between the phase A and B : T/4 ± T/8(1 cycle of A is T)			
	Response speed	200 KHz max.			
	Rated voltage	Voltage output	※ By the suffix code		
		Open collector	5 – 12 V d.c. ± 5 %		
		Totem pole output	12 – 24 V d.c. ± 5 %		
		Line driver	5 V d.c. ± 5 %	5 / 12 / 24 V d.c. ± 5 %	
	Current consumption	Max 60 mA(No load)			
	Connection type	Cable extended type			
	Control output	NPN voltage output	Load voltage : max 30 V, load current : max 30 mA		
		NPN open collector	Remaining voltage : max 0.4 V		
Totem pole		LOW (load current : max 30 mA, remaining voltage : max 0.4 V) HIGH (load current : max 10 mA, output voltage: above rated voltage – 2.5 V)			
Line driver	LOW (load current : max 20 mA, max 0.4 V)				
	HIGH (load current : max 20 mA, remaining voltage : above 2.5 V)				
Response time	Voltage output	Max 1 μs (wire length : 1.5 m, sinking current = 30 mA)			
	Open collector	Max 1 μs (wire length : 1.5 m, sinking current = 10 mA max.)			
	Totem pole	Max 1 μs (wire length : 1.5 m, sinking current = 30 mA max.)			
	Line driver	Max 1 μs (wire length : 1.5 m, sinking current = 30 mA max.)			
Mechanical specification	Starting torque	2×10 ⁻³ N·m	4×10 ⁻³ N·m	7×10 ⁻³ N·m	
	Moment of inertia	Max 2 × 10 ⁻⁶ kg·m ²	Max 4 × 10 ⁻⁶ kg·m ²	Max 8 × 10 ⁻⁶ kg·m ²	
	Permissible shaft loading	Radial : 15 N within Thrust : 10 N within	Radial : 30 N within Thrust : 20 N within	Radial : 50 N within Thrust : 30 N within	
	Max permissible revolution	5,000 r/min			
Environmental specification	Insulation resistance	Min 100 MΩ (between the terminal and case 500 V d.c. mega standard)			
	Dielectric strength	800 V a.c. (for 1 min in 60 Hz between the terminal and case)			
	Vibration resistance	10 – 55 Hz (period for 1 min), double amplitude : 1.5 mm, for 2 hour each in X, Y and Z directions			
	Shock resistance	Max 490 %	Max 735 %		
	Ambient temperature	-10 ~ 70 °C (no icing allowed), when storing: -25 ~ 85 °C			
	Ambient humidity	35 ~ 85 % RH			
	Cable	5 P, Ø5.0 mm, length: 1.5 m, shield cable(HE40B, HE50B cable length option : 2 m, 8 m, 10 m) (Line drive type : 8P, Ø5.0 mm, length : 1.5 m, shield cable)			
	Accessory	Ø 4.0 mm coupling	Ø 6.0 mm / Ø 8.0 mm coupling	Ø 8.0 mm coupling, bracket	
Weight	Approx. 120 g	Approx. 170 g	Approx. 200 g		

Suffix code

Model	Code	Information		
HE	<input type="checkbox"/> - <input type="checkbox"/> <input type="checkbox"/> <input type="checkbox"/> <input type="checkbox"/> <input type="checkbox"/>	Shaft rotary encoder (Incremental)		
Dimension	30B	4 Outer diameter : Ø 30 mm axis : Ø 4 mm		
	40B	6 Outer diameter : Ø 40 mm axis : Ø 6 mm		
		8 Outer diameter : Ø 40 mm axis : Ø 8 mm optional : (Option)		
	50B	8 Outer diameter : Ø 50 mm axis : Ø 8 mm		
Number of pulse	*	Refer to the pulse code chart(resolving power)		
Output signal	2	A, B phase output		
	3	A, B, Z phase output		
	3C	A, B, Z phase output		
	4	A, \bar{A} , B, \bar{B} phase output		
	6	A, \bar{A} , B, \bar{B} , Z, \bar{Z} phase output		
Output circuit	N	12	NPN voltage output (5 – 12 V d.c.)	
		24	NPN voltage output (12 – 24 V d.c.)	
		O	12	NPN open collector output (5 – 12 V d.c.)
			24	NPN open collector output (12 – 24 V d.c.)
	T	12	Totem pole output (5 – 12 V d.c.)	
		24	Totem pole output (12 – 24 V d.c.)	
	L	5	Line Driver output (5 V d.c.)	
		12	Line Driver output (12 V d.c.)	
24		Line Driver output (24 V d.c.)		

Apply only for HE40B, HE50B

(Note) A and B phase only can be generated with * mark(Line drive output : A, \bar{A} , B, \bar{B} , phase) Pulses other than the pulses in the chart are order made product

Pulse code chart (Resolving power)

Model	Number of pulse per 1 revolution
HE30B	100, 200, 360, 500, 1000, 1024
HE40B / HE50B	*1, *2, *5, 10, *12, 15, 20, 25, 30, 40, 45, 50, 60, 75, 100, 120, 125, 150, 192, 200, 240, 250, 256, 300, 360, 400, 500, 512, 600, 800, 1000, 1024,

Please contact us for the production of (Pulse).

Rotary Encoder

HE40H, HE60H Hollow shaft rotary encoder

Specification

MODEL		HE40H		
Appearance		CE		
Electrical specification	Phase difference on output	Phase difference between the phase A and B : $T/4 \pm T/8$ (1 cycle of A phase=T)		
	Response speed	200 KHz max.		
	Rated voltage	Voltage output	※ By the suffix code	
		Open collector	5 – 12 V d.c. $\pm 5\%$	
		Totem pole output	12 – 24 V d.c. $\pm 5\%$	
		Line driver	5 V d.c. $\pm 5\%$	
	Current consumption	Max 60 mA(no load), Line driver output less than 50 mA (no load)		
	Connection type	Cable extended type		
	Control output	NPN voltage output	Load voltage : max 30 V, load current : max 30 mA	
		NPN open collector	Remaining voltage : max 0.4 V	
		Totem pole	LOW (load current : max 30 mA, remaining voltage : max 0.4 V) HIGH (load current : max 10 mA, Output voltage: above rated voltage – 2.5 V)	
		Line driver	LOW (load current : max 20 mA, max 0.4 V) HIGH (load current : max 20 mA, remaining voltage : above 2.5V)	
	Response time	Voltage output	Max 1 μ s (wire length : 1.5 m, sinking current = 30 mA)	
		Open collector	Max 1 μ s (wire length : 1.5 m, sinking current = 10 mA max.)	
Totem pole		Max 1 μ s (wire length : 1.5 m, sinking current = 30 mA max.)		
Line driver		Max 1 μ s (wire length : 1.5 m, sinking current = 30 mA max.)		
Mechanical specification	Starting torque	4×10^{-3} N.m		
	Moment of inertia	4×10^{-6} g·cm ² max		
	Permissible shaft loading	Radial : 30 N within Thrust : 20 N within		
	Max permissible revolution	5,000 r/min		
Environmental specification	Insulation resistance	Min 100 M Ω (between the terminal and case 500 V d.c. mega standard)		
	Dielectric strength	800 V a.c. (for 1 min in 60 Hz between the terminal and case)		
	Vibration resistance	10 – 55 Hz (period for 1 min), double amplitude : 1.5 mm, for 2 hour each in X, Y and Z directions		
	Shock resistance	490 g $\frac{1}{2}$ max		
	Ambient temperature	-10 ~ 70 °C (no icing allowed), when storing: -25 ~ 85 °C		
	Ambient humidity	35 ~ 85 % RH		
	Cable	5 P, $\varnothing 5.0$ mm, length: 1.5 m, shield cable(HE40H cable length option : 2 m, 8 m, 10 m) (Line drive type : 8P, $\varnothing 5.0$ mm, length : 1.5 m, shield cable)		
	Weight	Approx. 170 g		

Suffix code

Model	Code					Information
HE	<input type="checkbox"/>	<input type="checkbox"/>	<input type="checkbox"/>	<input type="checkbox"/>	<input type="checkbox"/>	Hollow shaft rotary encoder (incremental)
Dimension	40H	6				Outer diameter : $\varnothing 40$ mm axis inner diameter : $\varnothing 6$ mm
		8				Outer diameter : $\varnothing 40$ mm axis inner diameter : $\varnothing 8$ mm
		10				Outer diameter : $\varnothing 40$ mm axis inner diameter : $\varnothing 10$ mm
		12				Outer diameter : $\varnothing 40$ mm axis inner diameter : $\varnothing 12$ mm
Number of pulse		*			Refer to the pulse code chart (resolving power)	
Output signal (output phase)		2				A, B phase output
		3				A, B, Z phase output
		3C				A, B, Z phase output
		4				A, \bar{A} , B, \bar{B} phase output
		6				A, \bar{A} , B, \bar{B} , Z, \bar{Z} phase output
Output circuit	N	12				NPN voltage output (5 – 12 V d.c.)
		24				NPN voltage output (12 – 24 V d.c.)
	O	12				NPN open collector output (5 – 12 V d.c.)
		24				NPN open collector output (12 – 24 V d.c.)
	T	12				Totem pole output (5 – 12 V d.c.)
		24				Totem pole output (12 – 24 V d.c.)
L					Line Driver output (5 V d.c.)	

(Note) A and B phase only can be generated with * mark(Line drive output : A, \bar{A} , B, \bar{B} , phase) Pulses other than the pulses in the chart are order made product

Pulse code chart (Resolving power)



Model	Number of pulse per 1 revolution
HE40H	*1, *2, *5, 10, *12, 15, 20, 25, 30, 40, 45, 50, 60, 75, 100, 120, 125, 150, 192, 200, 240, 250, 256, 300, 360, 400, 500, 512, 600, 800, 1000, 1024,

Please contact us for the production of (Pulse).

Rotary Encoder

HE30HB, HE40HB Blind shaft encoder

Specification

MODEL		HE30HB	HE40HB	
Appearance				
		CE		
Electrical specification	Phase difference on output	Phase difference between the phase A and B : T/4 ± T/8(1 cycle of A phase=T)		
	Response speed	200 KHz max.		
	Rated voltage	Voltage output	※ By the suffix code	
		Open collector	5 – 12 V d.c. ±5 %	
		Totem pole output	12 – 24 V d.c. ±5 %	
		Line driver	5 V d.c. ±5 %	5 / 12 / 24 V d.c. ±5 %
	Current consumption	Max 60 mA(No load), Line driver output less than 30 mA(No load)		
	Connection type	Cable extended type		
	Control output	NPN voltage output	Load voltage : max 30 V, load current : max 30 mA	
		NPN open collector	Remaining voltage : max 0.4 V	
Totem pole		LOW (load current : max 30 mA, remaining voltage : max 0.4 V) HIGH (load current : max 10 mA, Output voltage: above rated voltage – 2.5 V)		
Line driver	LOW (load current : max 20 mA, max 0.4 V)	HIGH (load current : max 20 mA, remaining voltage : above 2.5V d.c.)		
Response time	Voltage output	Max 1 μs (wire length : 1.5 m, sinking current = 30 mA)		
	Open collector	Max 1 μs (wire length : 1.5 m, sinking current = 10 mA max.)		
	Totem pole	Max 1 μs (wire length : 1.5 m, sinking current = 30 mA max.)		
	Line driver	Max 1 μs (wire length : 1.5 m, sinking current = 30 mA max.)		
Mechanical specification	Starting torque	2×10 ⁻³ N.m	4×10 ⁻³ N.m	
	Moment of inertia	2×10 ⁻⁶ Kg-m ² max	4×10 ⁻⁶ Kg-m ² max	
	Permissible shaft loading	Radial : 15 N within	Radial : 30 N within	
		Thrust : 10 N within	Thrust : 20 N within	
Max permissible revolution	5,000 rpm			
Environmental specification	Insulation resistance	Min 100 MΩ (between the terminal and case 500 V d.c. mega standard)		
	Dielectric strength	800 V a.c. (for 1 min in 60 Hz between the terminal and case)		
	Vibration resistance	10 – 55 Hz (period for 1 min), double amplitude : 1.5 mm, for 2 hour each in X, Y and Z directions		
	Shock resistance	490 % max	735 % max	
	Ambient temperature	-10 ~ 70 °C (no icing allowed), when storing: -25 ~ 85 °C		
	Ambient humidity	35 ~ 85 % RH		
	Wire specification	5 P, Ø5.0 mm, length: 1.5 m, shield cable (Line drive type : 8P, Ø5.0 mm, length : 1.5 m, shield cable)		
	accessory	Bracket		
Weight	Approx. 120g	Approx. 170g		

Suffix code

Model	Code	Information	
HE	<input type="checkbox"/> <input type="checkbox"/> <input type="checkbox"/> <input type="checkbox"/> <input type="checkbox"/> <input type="checkbox"/>	Blind shaft rotary encoder(Incremental)	
dimension	30HB	2	Outer diameter : Ø 30 mm axis inner diameter : Ø 2 mm
		2.5	Outer diameter : Ø 30 mm axis inner diameter : Ø 2.5 mm
		3	Outer diameter : Ø 30 mm axis inner diameter : Ø 3 mm
	40HB	6	Outer diameter : Ø 40 mm axis inner diameter : Ø 6 mm
		8	Outer diameter : Ø 40 mm axis inner diameter : Ø 8 mm
		10	Outer diameter : Ø 40 mm axis inner diameter : Ø 10 mm
	12	Outer diameter : Ø 40 mm axis inner diameter : Ø 12 mm	
Number of pulse	*	Refer to the pulse code chart(resolving power)	
Output signal (output phase)	2	A, B phase output	
	3	A, B, Z phase output	
	3C	A, B, Z̄ phase output	
	4	A, Ā, B, B̄ phase output	
	6	A, Ā, B, B̄, Z, Z̄ phase output	
Output circuit	N	24	NPN voltage output (12 – 24 V d.c.)
		12	NPN voltage output (5 – 12 V d.c.)
	O	24	NPN open collector output (12 – 24 V d.c.)
		12	NPN open collector output (5 – 12 V d.c.)
	T	24	Totem pole output (12 – 24 V d.c.)
		12	Totem pole output (5 – 12 V d.c.)
	L	5	Line Driver output (5 V d.c.)
		12	Line Driver output (12 V d.c.)—Apply only for HE40HB
	24	Line Driver output (24 V d.c.)—Apply only for HE40HB	

(Note) A and B phase only can be generated with * mark(Line drive output : A, Ā, B, B̄, phase) Pulses other than the pulses in the chart are order made product

Pulse code chart (Resolving power)

Model	Number of pulse per 1 revolution
HE30HB	100, 200, 360, 500, 1000, 1024
HE40HB	*1, *2, *5, 10, *12, 15, 20, 25, 30, 40, 45, 50, 60, 75, 100, 120, 125, 150, 192, 200, 240, 250, 256, 300, 360, 400, 500, 512, 600, 800, 1000, 1024

Please contact us for the production of (Pulse).

Rotary Encoder

■ PSC series Wheel type encoder

■ Specification

MODEL		PSC	
Appearance			
		CE	
Electrical specification	Phase difference on output	Phase difference between the A and B : $T/4 \pm T/8$ (1 cycle of A phase = T)	
	Response speed	100 KHz max.	
	Rated voltage	5 – 12 V d.c. ($\pm 5\%$), 12 – 24 V d.c. ($\pm 5\%$)	
	Current consumption	Max 60 mA	
	Connection type	Cable extended type	
	Control output	Voltage and open collector	Load voltage : max 30 V/load current : max 30 mA/Remaining voltage : max 0.4 V
		Totem pole	LOW (Load current : max 30 mA/Remaining voltage : max 0.4 V) HIGH (Load current : max 10 mA/Output voltage : above rated voltage – 1.5 V d.c.)
	Response time	Max 1 μ s (Wire length : 1.5 m lv sink = 30 mA)	
Mechanical specification	Starting torque	Max 200 gf·cm (19,600 u N·m)	
	Moment of inertia	Max 800 g·cm ² (8×10^{-6} kg·m ²)	
	Permissible shaft loading	Radial : 0.1 mm within, Thrust : 0.2 mm within	
	Max permissible revolution	5,000 rpm	
	Bearing life	1.2×10^7 (r/min) : time	
Environmental specification	Insulation resistance	Min 500 M Ω (Between the terminal and case)	
	Dielectric strength	500 V a.c. (For 1 min in 60 Hz between the terminal and case)	
	Vibration resistance	10 – 55 Hz (Period for 1 min), Double amplitude : 1.5 mm, for 2 hour each in X, Y and Z directions	
	Shock resistance	Max 75 G	
	Ambient temperature	-10 ~ 70 °C (No icing allowed), When storing : -25 ~ 85 °C	
	Ambient humidity	35 ~ 85 % RH	
	Wire specification	Number of strips : 5 P, Thickness : \varnothing 5.0 mm, Length : 1.5 m, Shield cable	
	Weight	Approx. 625 g	

■ Suffix code

Model	Code	Information
PSC-	<input type="checkbox"/> <input type="checkbox"/> <input type="checkbox"/> <input type="checkbox"/>	Wheel type encoder
Min length measurement	MA	1 m
	MB	1 cm
	MC	1 mm
	YA	1 YARD
	YB	0.1 YARD
	YC	0.01 YARD
Output signal	AB	A, B phase output (PSC-MA, YA), Rests are A, B, Z Phase output
Output Circuit	N	NPN voltage output
	O	NPN open collector
	T	Totem pole output
Power supply voltage	12	12 V d.c. (5 – 12 V d.c.)
	24	24 V d.c. (12 – 24 V d.c.)

※ Code PSC-MA and PSC-YA are A, B phase output. Rests are A, B, Z Phase output

Thyristor Power Regulator

TPR-2M Slim type 1-phase power regulator

Specification

Model	Economical type		Advanced type	
	Low voltage		Low voltage	High voltage
	TPR-2ME25L	TPR-2ME35L	TPR-2MS25L	TPR-2MS25H
Appearance				
W X H X D (mm)	47.5 X 90 X 112			
Function	• Soft start/Soft up/Soft down • Over heat alarm		• Soft start/Soft up/Soft down • Over heat alarm • Over current alarm • Slope setting • Output indication • Power failure alarm • SCR short alarm	
Load Voltage	100 – 240 V a.c.		100 – 440 V a.c.	
Circuit input power	100 – 240 V a.c. 3 W		24 V d.c. 1 W	
Power frequency	50 / 60 Hz (Dual usage)			
Rated current	25 A / 35 A			
Control Input	Current input	4 – 20 mA d.c. (Impedance : 100 Ω) (Basic packages)	4 – 20 mA d.c. (Impedance : 100 Ω) (Option)	
	Voltage input	1 – 5 V d.c. (Basic packages)	1 – 5 V d.c. (Option)	
	Contact input	ON/OFF (Basic packages)	ON/OFF (Option)	
	External VR	External VR (10 kΩ) Simultaneous use of current and voltage input is not supported	–	
Control method	Phase control (Basic), Variable Cycle control (Option)			
Movement type	Soft start (60 sec) / Soft up, Soft down (15 sec) / Adjust start time by SOFT VR			
Output voltage	More than 98 % of the power supply voltage (In case of maximum current input) / Output limitation control by Power VR			
Alarm function	–	O (Relay contact output) : Current error(CE), Over temperature(OT), Power error / Heater break(PE), SCR short (PE)		
Display method (LED)	Output	FIRE : Flicker speed directly proportional to output		
	Power	Light on when power connect to circuit	–	
	Alarm	–	CE (CURRENT ERROR) : Light on in case of more than 45 A load	
		–	OT (OVER TEMP) : Light on when Heat sink temperature is above 85 °C	
Cooling method	Natural cooling			
Weight	approx. 322 g			

Suffix code



Model	Code	Information
TPR-2M	<input type="checkbox"/> <input type="checkbox"/> <input type="checkbox"/> <input type="checkbox"/> <input type="checkbox"/>	Slim type 1- phase power regulator
Type	E	Economical type 25 A 100 – 24 V a.c. only
	S	Advanced type
Rated current	25	25 A
	35	35 A
Power supply voltage	L	100 – 240 V a.c.
	H	100 – 440 V a.c. (Only for advanced type)
Control input (For Advanced type only)	C	4 – 20 mA d.c.
	V	1 – 5 V d.c.
	O	ON/OFF
		Economical Type(E) supports all input options.

※ Please supply power separately for circuit input (100 – 240 V a.c. for low voltage, 24 V d.c. for high voltage)

Thyristor Power Regulator

TPR-2N 1-phase thyristor power regulator

Specification

MODEL	TPR-2N□□□	TPR-2N□□□□
Appearance		
W X H X D	92 X 100.2 X 131.6	115.2 X 194.7 X 123.6
Function	• Soft Start / Soft Down • Slope setting	• Soft start • Overheated alarm (O.T) • Alarm output • Slope setting • Output limit setting • Overcurrent detection (O.C) • Load break detection (L.L)
Power supply voltage	110 V a.c. / 220 V a.c. / 380 V a.c.	110 V a.c. / 220 V a.c. / 380 V a.c. / 440 V a.c.
Operating Frequency	50 / 60 Hz (Dual usage)	
Rated Current	25 A, 35 A	50 A, 70 A
Protection Circuit	Protected by fast acting fuse (external attachment)	
Applied Load	Resistive Load/ Inductive Load	
Control Input	Input Current : 4 – 20 mA d.c. Input Voltage : 1 – 5 V d.c. Input Contact Point : ON – OFF, External VR (10 kΩ)	Current input : 4 – 20 mA d.c., Voltage input : 1 – 5 V d.c. / 0 – 10 V d.c. (Option) Contact input : ON / OFF, External VR : External volume (10 kΩ)
Control Method	Phase control, Cycle control, ON/OFF control (selected by dip switch)	
Movement type	Soft start / Soft down (Time : 0 ~ 50 sec)	Soft start / Soft down
Output Adjusting Range	Above 95 % input voltage (when putting maximum of input voltage)	
Cooling Method	Natural Cooling	50 A(Natural cooling), 70 A (Forced cooling)
Indicator Function	LED lighting for output status	
Insulation Resistance	100 MΩ min (500 V d.c. mega standard)	
Output Range	0 ~ 100 %	
Dielectric Strength	2,000 V a.c. at 50/60 Hz for 1 minute	
Line Noise	Noise by noise simulator (pulse width 1 μs : ±2 KV)	
Ambient temperature	0 ~ 50 °C (Without condensation)	
Ambient Humidity	30 ~ 85 % RH	
Storage Temperature	-25 ~ 70 °C	
Weight	Approx. 960 g	Approx 2,000 g

Suffix code (25 A / 35 A)

※ Control Method : Phase control (factory default)

Model	Code	Information
TPR – 2N	□ : □	1-phase power regulator
Power supply voltage	110 :	110 V a.c. 50/60 Hz (Dual usage)
	220 :	220 V a.c. 50/60 Hz (Dual usage)
	380 :	380 V a.c. 50/60 Hz (Dual usage)
Rated current	25	25 A
	35	35 A

Suffix code (50A / 70A)

Model	Code	Information
TPR – 2N	□ : □	1-phase power regulator
Power supply voltage	110 :	110 V a.c. 50/60 Hz (Dual usage)
	220 :	220 V a.c. 50/60 Hz (Dual usage)
	380 :	380 V a.c. 50/60 Hz (Dual usage)
	440 :	440 V a.c. 50/60 Hz (Dual usage)
Rated current	50	50 A
	70	70 A

Thyristor Power Regulator

TPR-2SL Slim type 1-phase power regulator

Specification

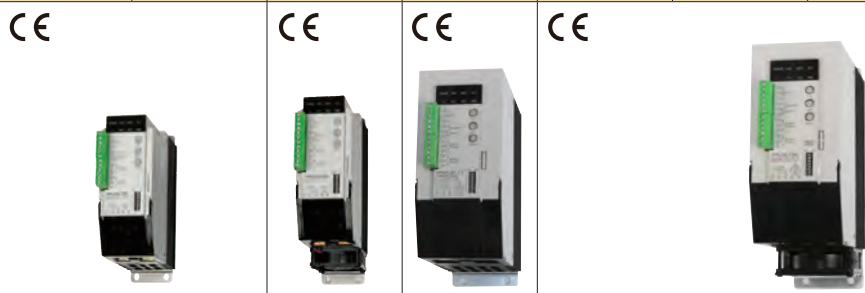
Model	Low	TPR-2SL040L	TPR-2SL055L	TPR-2SL070L	TPR-2SL090L	TPR-2SL110L	TPR-2SL130L	TPR-2SL160L	TPR-2SL200L	
	High	TPR-2SL040H	TPR-2SL055H	TPR-2SL070H	TPR-2SL090H	TPR-2SL110H	TPR-2SL130H	TPR-2SL160H	TPR-2SL200H	
Appearance										
Function	<ul style="list-style-type: none"> Ultra Slim type (60 mm) Improve reliability by separating circuit power and load power (Apply a wide range of power supply circuit) Realized various control methods according to the variety of load. Alarm output is divided as caution and warning. Various protection functions for partial heater break, overcurrent, overheated heat sink, SCR short-circuit 									
Power supply voltage	Low	100 – 240 V a.c.								
	High	380 – 440 V a.c.								
Circuit input power	100 – 240 V a.c.			100 – 240 V a.c.						
	6 W			16 W			20 W			
Power frequency	50 / 60 Hz (Dual usage)									
Rated current (40 °C Standard)	40 A	55 A	70 A	90 A	110 A	130 A	160 A	200 A		
Fuse installation	None (selectable option)				Built-in fast acting fuse					
Applying load	Resistive load									
Control Input	Current input	4 – 20 mA d.c. (Impedance : 100 Ω)								
	Voltage input	1 – 5 V d.c. (Option : 0 – 10 V d.c.)								
	Contact input	ON/OFF								
	External VR	External volume (10 kΩ)								
Control method	Phase control, Fixed Cycle control, Variable Cycle control, ON/OFF control									
Movement type	Soft start / Soft up, down									
Output voltage	More than 98 % of the power supply voltage (In case of maximum current input)									
Cooling method	Natural cooling			Forced cooling	Natural cooling			Forced cooling		
Display method	Display by LED									
Insulation resistance	Min 100 MΩ (Base on 500 V d.c. mega)									
Output control range	0 ~ 100 %									
Dielectric strength	3,000 V a.c. 50/60 Hz for 1 min									
Line noise	Noise by noise simulator (3,000 V)									
Ambient temperature	20 ~ 80 °C (Without condensation)									
Ambient Humidity	30 ~ 85 % RH									
Storage temperature	-25 ~ 70 °C									
Weight	1,388 g			1,478 g		2,820 g		3,100 g		

Suffix code

Model	Code	Information
TPR-2SL	<input type="checkbox"/> <input type="checkbox"/> <input type="checkbox"/> <input type="checkbox"/>	Slim type 1- phase power regulator
Rated current	040	40 A
	055	55 A
	070	70 A
	090	90 A
	110	110 A
	130	130 A
	160	160 A
	200	200 A
Power supply voltage	L	100 – 240 V a.c. (Low)
	H	380 – 440 V a.c. (High)
Options	C	RS485
	F	Built-in fuse type (For option 50 / 55 / 70 A)

※ Circuit and FAN need 100 – 240 V a.c. voltage power separately.

Thyristor Power Regulator

TPR-2SE Slim type 1-phase power regulator

Specification

Model	Low	TPR-2SE025L	TPR-2SE040L
	High	TPR-2SE025H	TPR-2SE040H
Appearance			
W X H X D	47 X 138 X 151.7		
Function	<ul style="list-style-type: none"> • Soft start/Soft up/Soft down, • Over heat alarm, • Over current alarm, • Slope setting • Load break alarm, • Output indication, • Power failure alarm, • SCR short alarm 		
Power supply voltage	Low	100 – 240 V a.c.	
	High	100 – 440 V a.c.	
Circuit input power	100 – 240 V a.c. 6 W		
Power frequency	50 / 60 Hz (Dual usage)		
Rated current (40 °C Standard)	25 A	40 A	
Fuse installation	None		
Applying load	Resistive load		
Control Input	Current input	4 – 20 mA d.c. (Impedance : 100 Ω)	
	Voltage input	1 – 5 V d.c.	
	Contact input	ON/OFF	
	External VR	External volume (10 kΩ)	
Control method	Phase control, Fixed Cycle control, Variable Cycle control, ON/OFF control		
Movement type	Soft start / Soft up, down		
Output voltage	More than 98 % of the power supply voltage (In case of maximum current input)		
Cooling method	Natural cooling		
Display method	Display by LED		
Insulation resistance	Min 100 MΩ (Base on 500 V d.c. mega)		
Output control range	0 ~ 100 %		
Dielectric strength	3,000 V a.c. 50/60 Hz for 1 min		
Line noise	Noise by noise simulator (3,000 V)		
Ambient temperature	0 ~ 40 °C (Without condensation)		
Ambient Humidity	30 ~ 85 % RH		
Storage temperature	-25 ~ 70 °C		
Weight	1,388 g		

Suffix code

Model	Code	Information
TPR-2SE	<input type="checkbox"/> <input type="checkbox"/> -	Slim type 1- phase power regulator
Rated current	025	25 A
	040	40 A
Power supply voltage	L	100 – 240 V a.c. (Low)
	H	100 – 440 V a.c. (High)

Temperature Controller
Recorder
Digital Counter
Timer
Analog Timer
Panel Meter
Multi Pulse Meter
Proximity Sensor
Photo Sensor
Rotary Encoder
Thyristor Power Regulator
Solid State Relay
Power Supply
Control Switch
Push Button / Main Switch
Cam Switch / Limit Switch
Micro / Hoist Switch
Foot / Mono Lever Switch
Signal Light
Terminal Block / Power Buzzer / Fuse Holder / Control Box

Thyristor Power Regulator

TPR-3M Mini 3-phase power regulator

Specification

Model	TPR-3M25L	TPR-3M45L
Appearance		
W X H X D	110 X 157.5 X 150	
Function	• Over heat alarm, • Over current alarm, • Load break alarm, • Output indication, • SCR short alarm	
Power supply voltage	100 – 240 V a.c.	
Circuit input power	24 V d.c. 8 W	
Power frequency	50 / 60 Hz	
Rated current	25 A	45 A
Applying load	Resistive load	
Control Input	4 – 20 mA d.c. (Impedance : 100 Ω)	
Control method	Phase control (Fixed Cycle control, Variable Cycle control Option)	
Output voltage	More than 98 % of the power supply voltage (In case of maximum current input)	
Cooling method	Forced cooling (24 V d.c. FAN)	
Display method	4 LED display status and alarm status	
Insulation resistance	Min 100 MΩ (Base on 500 V d.c. mega)	
Dielectric strength	2,500 V a.c. 50 / 60 Hz for 1 min	
Line noise	Noise by noise simulator (2,000 V)	
Storage temperature	–30 ~ 90 °C	
Ambient temperature	–20 ~ 80 °C (Without condensation)	
Ambient Humidity	45 ~ 85 % RH	
Weight	1,756 g	

Suffix code



Model	Code	Information
TPR-3M	<input type="checkbox"/> <input type="checkbox"/> <input type="checkbox"/>	Mini 3-phase power regulator
Rated current	25	25 A
	45	45 A
Power supply voltage	L	100 – 240 V a.c. (Low)
Option	IS	Power isolation for multi series connection

※ IS type support connection in series up to 5 units with 1 temperature controller or power supply (SMPS.)
The general type requires a 1 to 1 connection to the temperature controller with a 24 V d.c. partial power circuit as a non-isolated type.

Thyristor Power Regulator

TPR-3SL Slim type 3-phase power regulator

Specification

Model	Low	TPR-3SL040L	TPR-3SL055L	TPR-3SL070L	TPR-3SL090L	TPR-3SL130L	TPR-3SL160L
	High	TPR-3SL040H	TPR-3SL055H	TPR-3SL070H	TPR-3SL090H	TPR-3SL130H	TPR-3SL160H
Appearance	CE		CE		CE		
							
Function	• Soft start / Soft up, down, • Over heat alarm, • Over current alarm, • Slope setting, • Load break alarm, • Output indication, • Power failure alarm, • SCR short alarm						
Power supply voltage	Low	100 – 240 V a.c.					
	High	380 – 440 V a.c.					
Circuit input power	100 – 240 V a.c. 18 W			100 – 240 V a.c. 20 W			
Power frequency	50 / 60 Hz (Dual usage)						
Rated current	40 A, 55 A, 70 A, 90 A, 130 A, 160 A						
Applying load	Resistive load						
Control Input	Current input	4 – 20 mA d.c. (Impedance : 100 Ω)					
	Voltage input	1 – 5 V d.c.					
	Contact input	ON / OFF					
	External VR	External volume (10 KΩ)					
Control method	Phase control, Fixed Cycle control, Variable Cycle control, ON/OFF control						
Movement type	Soft start / Soft up, down						
Output voltage	More than 98 % of the power supply voltage (In case of maximum current input)						
Cooling method	Natural cooling (40 A, 55 A), Forced cooling (70 A, 90 A, 130 A, 160 A)						
Display method	Display by LED						
Insulation resistance	Min 100 MΩ (Base on 500 V d.c. mega)						
Output control range	0 ~ 100 %						
Dielectric strength	3,000 V a.c. 50/60 Hz for 1 min						
Line noise	Noise by noise simulator (2,500 V)						
Ambient temperature	0 ~ 40 °C (Without condensation)						
Ambient Humidity	30 ~ 85 % RH						
Storage temperature	-25 ~ 70 °C						
Weight	4,044 g		4,324 g		9,100 g		9,194 g

Suffix code

Model	Code	Information
TPR-3SL	<input type="checkbox"/> <input type="checkbox"/> <input type="checkbox"/>	Slim type 3-phase power regulator
Rated current	040	40 A
	055	55 A
	070	70 A
	090	90 A
	130	130 A
	160	160 A
Power supply voltage	L	100 – 240 V a.c. (Low)
	H	380 – 440 V a.c. (High)
Option	-	Fuse built-in
	N	No fuse

※ Circuit and FAN need 100 – 240 V a.c. voltage power separately.

Temperature Controller
Recorder
Digital Counter
Timer
Analog Timer
Panel Meter
Multi Pulse Meter
Proximity Sensor
Photo Sensor
Rotary Encoder
Thyristor Power Regulator
Solid State Relay
Power Supply
Control Switch
Push Button / Main Switch
Cam Switch / Limit Switch
Micro / Hoist Switch
Foot / Mono Lever Switch
Signal Light
Terminal Block / Power Buzzer / Fuse Holder / Control Box

Thyristor Power Regulator

TPR-3SL-EP 1-phase X 3 power regulator

Specification

Model	TPR-3SL040H-EP	TPR-3SL055H-EP	TPR-3SL070H-EP	TPR-3SL090H-EP	TPR-3SL130H-EP	TPR-3SL160H-EP
Appearance						
Function	<ul style="list-style-type: none"> • Soft start / Soft up, down • Over heat alarm • Over current alarm • Slope setting • Load break alarm • Output indication • Power failure alarm • SCR short alarm 					
Power supply voltage	100 – 440 V a.c.					
Circuit input power	100 – 240 V a.c. 18 W					
Power frequency	50/60 Hz (Dual usage)					
Rated current	40 A	55 A	70 A	90 A	130 A	160 A
Applying load	Resistive load					
Current input	4 – 20 mA d.c. (Impedance : 100 Ω)					
Control method	Phase control, Fixed Cycle control, Variable Cycle control, ON/OFF control					
Movement type	Soft start / Soft up, down					
Output voltage	More than 98 % of the power supply voltage (In case of maximum current input)					
Cooling method	Forced cooling					
Display method	Display by LED					
Insulation resistance	Min 100 MΩ (Base on 500 V d.c. mega)					
Output control range	0 ~ 100 %					
Dielectric strength	3,000 V a.c. 50/60 Hz for 1 min					
Line noise	Noise by noise simulator (2,500 V)					
Ambient temperature	0 ~ 40 °C (Without condensation)					
Ambient Humidity	30 ~ 85 % RH					
Storage temperature	-25 ~ 70 °C					
Weight	4,324 g			9,194 g		9,288 g

Suffix code

Model	Code	Information
TPR-3SL	<input type="checkbox"/> <input type="checkbox"/> -EP	1-phase X 3 power regulator
Rated current	040	40 A
	055	55 A
	070	70 A
	090	90 A
	130	130 A
	160	160 A
Power supply voltage	H	100 – 440 V a.c.

※ Circuit and FAN need 100 – 240 V a.c. voltage power separately.

※ 130 A and 160 A products need 24 V d.c. power separately for FAN (Only for TPR-3SL EP models)

Thyristor Power Regulator

TPR-3N 3 phases thyristor controller

Specification

MODEL	TPR-3N□35MR	TPR-3N□50MR	TPR-3N□60MR
Appearance			
W X H X D (mm)	195 X 266 X 150		
Rated current	35 A	50 A	60 A
Function	<ul style="list-style-type: none"> • Power failure and fuse break (L,E) alarm output • Overcurrent detection alarm output • Current limit setting • Manual setting (slope setting) 		
Display method	Output displayed by the LED		
Control method	Phase control, ON/OFF control		
Applying load	Resistive load/Inductance load		
Power supply voltage	220, 380, 440 V a.c.		
Power frequency	50 Hz or 60 Hz (Dual usage)		
Output voltage	More than 95% of the input voltage (with the max current input)		
Controlling element	SCR		
Control input	4 – 20 mA ※ 0 – 5 V d.c., 1 – 5 V d.c., 0 – 10 V d.c.		
External volume	External volume (B10 KΩ)		
Alarm output	Power failure and fuse break (L,E) alarm output, Overcurrent detection alarm output, Relay contact output(1a contact), 5 A 250 V a.c. max		
Insulation resistance	min 20 MΩ, 500 V d.c. (between input terminal and power terminal)		
Dielectric strength	For 1 minute at 2,000 V a.c. 50/60 Hz		
Cooling method	Natural cooling	Forced cooling	
Ambient temperature	0 ~ 50 °C (Refer to the ambient temperature characteristic)		
Ambient humidity	35 ~ 85 % RH (No condensation allowed)		
Storage temperature	-25 ~ 70 °C		
Weight	Approx 5,350 g		

Suffix code

Model	Code	Information
TPR-3N	□ □ □ □ □	3-phases thyristor controller
Control type	P	Phase control, ON/OFF control
Power supply voltage	220	220, 380, 440 V a.c. (※ Voltage selectable)
Rated current	35	35, 50, 60 A (※ Capacity selectable)
Control input	M	4 – 20 mA d.c. ※ 1 – 5 V d.c.
Applying load	R	Resistive load

Temperature Controller

Recorder

Digital Counter
TimerAnalog
TimerPanel
MeterMulti Pulse
MeterProximity
SensorPhoto
SensorRotary
EncoderThyristor
Power
RegulatorSolid
State
RelayPower
SupplyControl
SwitchPush Button /
Main
SwitchCam Switch /
Limit
SwitchMicro /
Hoist
SwitchFoot /
Mono Lever
SwitchSignal
LightTerminal Block /
Power Buzzer /
Fuse Holder /
Control Box

Thyristor Power Regulator

TPR-3 3 phase power regulator

Specification

Model	TPR-3P□70MR	TPR-3P□100MR	TPR-3P□150MR	TPR-3P□200MR	TPR-3P□250MR	TPR-3P□320MR	TPR-3P□500MR	TPR-3P□600MR
Appearance								
W X H X D (mm)	235×360×180		256×440×200			266×524×225	337×548×237	338×613×253
Function	<ul style="list-style-type: none"> • Power failure and fuse break (L,E) alarm output • Overcurrent detection alarm output • Current limit setting • Soft start down • Manual setting (slope setting) 							
Power supply voltage	220 V a.c. / 380 V a.c. / 440 V a.c.							
Applying frequency	50 Hz / 60 Hz(Dual usage)							
Rated current	70 A	100 A	150 A	200 A	250 A	320 A	500 A	600 A
Protective circuit	Fuse break alarm, Over current alarm, Overheating heat sink							
Applying load	Resistive load / Inductive load							
Control input	Current Input	4 – 20 mA d.c.						
	Voltage Input	0 – 5 V d.c. / 1 – 5 V d.c. / 0 – 10 V d.c.						
	Contact Input	ON/OFF						
	External VR	External volume (10 KΩ)						
Control type	Phase control, ON/OFF control, Cycle control							
Start type	Soft start / Soft down							
Output voltage	More than 95 % of the power supply voltage (In case of maximum current input)							
Cooling type	Forced cooling (150 A ~ 600 A), Forced cooling (70 A, 100 A), Need separate power supply for FAN (320 A, 500 A and 600 A)							
Display method	Display by LED light							
Insulation resistance	Min 100 MΩ (Base on 500 V d.c. mega)							
Output adjustable range	0 ~ 100 %							
Dielectric strength	2,000 V a.c. 50/60 Hz for 1 min							
Line noise	Noise by noise simulator (2 kW)							
Ambient temperature	0 ~ 40 °C (Without condensation)							
Ambient humidity	35 ~ 85 % RH							
Storage temperature	-25 ~ 70 °C							
Weight	11 kg		15 kg			22 kg	35 kg	40 kg

Suffix code

Model	Code	Description
TPR-3P	□ □	3-phase power regulator
Power supply voltage	220	220 V a.c.
	380/440	380 V a.c. / 440 V a.c.
Rated current	70	70 A
	100	100 A
	150	150 A
	200	200 A
	250	250 A
	320	320 A
	500	500 A
	600	600 A

Thyristor Power Regulator

TPR-3N 3 phase power regulator

Specification

MODEL	TPR-3N□□□	
Appearance		
W X H X D (mm)	169 X 361 X 180	
Function	<ul style="list-style-type: none"> • LED display function • input signal selection • Operation mode selection (resistive load, inductive load) • Overcurrent alarm output (OC) • Power failure and fuse break alarm output • Load break alarm (LL) • Alarm output • LED ON when heat sink is overheated (OT) (thermal start fixed to 85 °C) 	
Number of phase	Three phase	
Rated current	70 A, 100 A	
Control method	Phase control, ON/OFF control	
Applying load	Resistive load, inductive load	
Power supply voltage	(220, 380, 440 V) a.c. 50/60 Hz(dual usage)	
Output voltage range	More than 95 % of the input voltage (min load more than 0.5A)	
Input signa	4 – 20 mA d.c., 0 – 5, 1 – 5, 0 – 10 V d.c. contact input, manual setting	
Output setting range	<ul style="list-style-type: none"> • Slope setting : 50 % (when inductive load is selected) • Output Limit : 0 ~ 100 % • Manual setting : 0 ~ 100 % (selected by the external B 10 KΩ volume or parameter) 	
Movement method	• Soft Up / Soft Down (setting : 0 ~ 50 sec)	
Alarm output	<ul style="list-style-type: none"> • Overcurrent alarm (OC) • Power failure and fuse break alarm • Load break (LL)alarm • Overheated heat sink • Relay contact output (1a contact) • 250 V a.c., 10 A max. (resistive load) 	
Insulation resistance	Min 100 MΩ, 500 V d.c.	
Dielectric strength	2,000 V, for 1 min	
Cooling method	Forced cooling by the FAN	
Ambient temperature	0 ~ 50 °C	
Ambient humidity	35 ~ 85 % RH (no condensation allowed)	
Storage temperature	-25 ~ 70 °C	
Weight	Approx 5 kg (Included the weight of box)	

Suffix code

Model	Code	Description
TPR-3N	□ □	3-phase power regulator
Power supply voltage	220	220 V a.c.
	380	380 V a.c.
	440	440 V a.c.
Rated current	70	70 A
	100	100 A

Temperature Controller
Recorder
Digital Counter
Timer
Analog Timer
Panel Meter
Multi Pulse Meter
Proximity Sensor
Photo Sensor
Rotary Encoder
Thyristor Power Regulator
Solid State Relay
Power Supply
Control Switch
Push Button / Main Switch
Cam Switch / Limit Switch
Micro / Hoist Switch
Foot / Mono Lever Switch
Signal Light
Terminal Block / Power Buzzer / Fuse Holder / Control Box

Solid State Relay

SSR-2 series Single phase solid state relay

Specification

DC input – AC load

Model		Low	SSR-2D102Z	SSR-2D202Z	SSR-2D302Z	SSR-2D402Z
		High	SSR-2D104Z	SSR-2D204Z	SSR-2D304Z	SSR-2D404Z
Appearance						
W X H X D (mm)		42 X 64 X 27.3				
L O A D	Rated Load Voltage	Low	90 – 264 V a.c.			
		High	90 – 480 V a.c.			
	Peak Voltage (Non-repetition)	Low	600 V			
		High	800 V	1,200 V		
	Rated load current		10 A	20 A	30 A	40 A
	Frequency		50/60 Hz (Dual usage)			
	Surge current (8.3 ms No repetition)	Low	170 A	260 A	420 A	
		High	170 A	250 A	370 A	
	Leakage current		20 mA max			
	Output ON voltage dropping		Less than 1.6 V (R.M.S)			
I N P U T	Rated Voltage		5 – 24 V d.c.			
	Operating Voltage Range		4.6 – 32 V d.c.			
	Impedance		Less than 4 kΩ			
	Operation Voltage		more than 4.6 V d.c.			
	Input Current		Constant-current system : 8 mA (±3)			
Response Time		1/2 Cycle + 1 ms max. ("R" type below 1 ms)				
Insulating Resistance		500 V d.c., 100 MΩ (Between the input / output and case)				
Dielectric strength		2,500 V a.c. (For 1 min at 60 Hz)				
Vibration resistance		10 – 55 Hz, Double amplitude : 1.5 mm, X,Y, and Z direction for 2 hours				
Shock resistance		1,000 ٪, X,Y,Z each axis 3 times				
Storage Temperature		-30 ~ 90 °C				
Ambient Temperature		-5 ~ 40 °C (But without frostiness)				
Ambient Humidity		45 ~ 85 % RH				
Pollution level grade		2level pollution				
Usage		Resistive load / Inductive load				
Accepted standard		IEC 62314				
Weight		Approx. 89g				

Solid State Relay

■ AC input – AC load

Model		Low	SSR-2A102Z	SSR-2A202Z	SSR-2A302Z	SSR-2A402Z		
		High	SSR-2A104Z	SSR-2A204Z	SSR-2A304Z	SSR-2A404Z		
Appearance							Temperature Controller	
W X H X D (mm)		42 X 64 X 27,3					Recorder	
LOAD	Rated Load Voltage	Low	90 – 264 V a.c.				Digital Counter	
		High	90 – 480 V a.c.				Timer	
	Peak Voltage (Non-repetition)	Low	600 V					Analog Timer
		High	800 V	20 A		30 A	40 A	
	Rated load current		10 A	20 A	30 A	40 A	Panel Meter	
	Frequency		50/60 Hz (Dual usage)					
	Surge current (8,3 ms No repetition)	Low	170 A	260 A	420 A			
		High	170 A	250 A	370 A			
	Leakage current		20 mA max					Multi Pulse Meter
	Output ON voltage dropping		Less than 1,6 V (RMS)					Proximity Sensor
INPUT	Rated Voltage		100 – 240 V a.c.					
	Operating Voltage Range		70 – 264 V a.c.					
	Impedance		Less than 40 kΩ					
	Operation Voltage		more than 70 V a.c.					
	Input Current		220 V a.c. : 8 mA					
Response Time		1/2 Cycle + 1 ms max. ("R" type below 1 ms)					Photo Sensor	
Insulating Resistance		500 V d.c., 100 MΩ (Between the input / output and case)					Rotary Encoder	
Dielectric strength		2,500 V a.c. (For 1 min at 60 Hz)						
Vibration resistance		10 – 55 Hz, Double amplitude : 1,5 mm, X,Y, and Z direction for 2 hours					Thyristor Power Regulator	
Shock resistance		1,000 %, X,Y,Z each axis 3 times					Solid State Relay	
Storage Temperature		-30 ~ 90 °C						
Ambient Temperature		-5 ~ 40 °C (But without frostiness)					Power Supply	
Ambient Humidity		45 ~ 85 % RH						
Pollution level grade		2level pollution					Control Switch	
Usage		Resistive load / Inductive load						
Accepted standard		IEC 62314					Foot / Mono Lever Switch	
Weight		Approx. 89g						

■ Suffix code



Model	Code	Information
SSR-2	<input type="checkbox"/> <input type="checkbox"/> <input type="checkbox"/> <input type="checkbox"/> <input type="checkbox"/>	Single phase solid state relay
Input Control Voltage	D	5 – 24 V d.c.
	A	100 – 240 V a.c.
Rated load current	10	10 A
	20	20 A
	30	30 A
	40	40 A
Rated load voltage	2	90 – 264 V a.c. (Low)
	4	90 – 480 V a.c. (High)
Operation method	Z	Zero Cross Switching (Standard product)
	R	Random Switching

Solid State Relay



■ HSR-2 series Single phase solid state relay

■ Specification



■ DC input – AC load (Low voltage : 90 – 264 V a.c.)

Model		HSR-2D102□	HSR-2D202□	HSR-2D302□	HSR-2D402□	HSR-2D502□	HSR-2D702□
Appearance		 					
W X H X D (mm)		44 X 64 X 29					
Input	Rated voltage	5 – 24 V d.c.					
	Voltage use range	4 – 32 V d.c.					
	Impedance	Less than 4 kΩ					
	Operating voltage	More than 3 V d.c.					
	Release voltage	Less than 1.5 V					
Load	Rated load voltage	100 – 240 V a.c.					
	Load voltage range	90 – 264 V a.c.					
	Rated load current	10 A	20 A	30 A	40 A	50 A	70 A
	Input current	170 A	250 A	315 A		580 A	
	Output voltage drop	1.3 V	1.6 V			1.8 V	
	Leakage current	10 mA					15 mA

■ AC input – AC load (Low voltage : 90 – 264 V a.c.)



Model		HSR-2A102□	HSR-2A202□	HSR-2A302□	HSR-2A402□	HSR-2A502□	HSR-2A702□
Appearance		 					
W X H X D (mm)		44 X 64 X 29					
Input	Rated voltage	100 – 240 V d.c.					
	Voltage use range	90 – 264 V d.c.					
	Impedance	Less than 40 kΩ					
	Operating voltage	More than 72 V a.c.					
	Release voltage	Less than 40 V a.c.					
Load	Rated load voltage	100 – 240 V a.c.					
	Load voltage range	90 – 264 V a.c.					
	Rated load current	10 A	20 A	30 A	40 A	50 A	70 A
	Input current	170 A	250 A	315 A		580 A	
	Output voltage drop	1.3 V	1.6 V			1.8 V	
	Leakage current	15 mA					

■ DC input – AC load (High voltage : 90 – 480 V a.c.)

Model		HSR-2D104□	HSR-2D204□	HSR-2D304□	HSR-2D404□	HSR-2D504□	HSR-2D704□
Appearance		 					
W X H X D (mm)		44 X 64 X 29					
Input	Rated voltage	5 – 24 V d.c.					
	Voltage use range	4 – 32 V d.c.					
	Impedance	Less than 4 kΩ					
	Operating voltage	More than 3 V d.c.					
	Release voltage	Less than 1.4 V d.c.					
Load	Rated load voltage	100 – 440 V a.c.					
	Load voltage range	90 – 480 V a.c.					
	Rated load current	10 A	20 A	30 A	40 A	50 A	70 A
	Input current	170 A	250 A	350 A	370 A	580 A	
	Output voltage drop	1.3 V	1.6 V			1.8 V	
	Leakage current	20 mA					

Solid State Relay

■ AC input – AC load (High voltage : 90 – 480 V a.c.)

Model	HSR-2A104□	HSR-2A204□	HSR-2A304□	HSR-2A404□	HSR-2A504□	HSR-2A704□	
Appearance	 						
W X H X D (mm)	44 X 64 X 29						
Input	Rated voltage	100 – 240 V a.c.					
	Voltage use range	90 – 264 V a.c.					
	Impedance	Less than 40 kΩ					
	Operating voltage	More than 75 V a.c.					
	Release voltage	Less than 40 V a.c.					
Load	Rated load voltage	100 – 440 V a.c.					
	Load voltage range	90 – 480 V a.c.					
	Rated load current	10 A	20 A	30 A	40 A	50 A	70 A
	Input current	170 A	250 A	350 A	370 A	580 A	
	Output voltage drop	1.3 V	1.6 V	1.8 V			
Leakage current	15 mA				20 mA		

■ General specification

Insulation resistance	500 V d.c. 100 MΩ (Between I/O and case)
Dielectric strength	2,500 V a.c. (1minute at 60Hz)
Vibration resistance	10 – 55 Hz Double amplitude width 1.5 mm/ X,Y,Z each direction for 2 hours
Shock resistance	1,000 % (Approx100G) X,Y,Z each axis 3 times
Storage temperature	-30 ~ 90 °C
Ambient temperature	-20 ~ 80 °C
Ambient humidity	45 ~ 85 % RH
Net weight	Approx. 150 g (Including packing box)

■ Suffix code

Model	Code	Information
HSR-2	□ □ □ □ □	Single phase solid state relay
Input voltage	D	4 – 32 V d.c.
	A	90 – 264 V a.c.
Rated load current	10	10 A
	20	20 A
	30	30 A
	40	40 A
	50	50 A
Load voltage	2	90 – 264 V a.c. (low voltage)
	4	90 – 480 V a.c. (high voltage)
Operation method	Z	Zero Cross Switching
	R	Random Switching
Radiator attachment state	-	No indication (no radiator)
	T	Radiator in one body type (only with 50 A and 70 A)

Solid State Relay

■ SSR-3 series 3-phase solid state relay

■ DC input – AC load

Model		Low	SSR-3D102Z	SSR-3D202Z	SSR-3D302Z	SSR-3D402Z
		High	SSR-3D104Z	SSR-3D204Z	SSR-3D304Z	SSR-3D404Z
Appearance						
W X H X D (mm)		109 X 60 X 31,25				
L O A D	Rated Load Voltage	Low	90 – 264 V a.c.			
		High	90 – 480 V a.c.			
	Peak Voltage (Non-repetition)	Low	600 V			
		High	800 V	1,200 V		
	Rated load current		10 A	20 A	30 A	40 A
	Frequency		50/60 Hz (Dual usage)			
	Surge current (8,3 ms No repetition)	Low	170 A	260 A	420 A	
		High	170 A	250 A	370 A	
Leakage current		20 mA max				
Output ON voltage dropping		Less than 1.6 V (RMS)				
I N P U T	Rated Voltage		5 – 24 V d.c.			
	Operating Voltage Range		4,6 – 32 V d.c.			
	Impedance		Less than 4 kΩ			
	Operation Voltage		more than 4,6 V d.c.			
	Input Current		Constant-current system : 12 mA (±3)			
Response Time		1/2 Cycle + 1 ms max. ("R" type below 1 ms)				
Insulating Resistance		500 V d.c., 100 MΩ (Between the input / output and case)				
Dielectric strength		2,500 V a.c. (For 1 min at 60 Hz)				
Vibration resistance		10 – 55 Hz, Double amplitude : 1,5 mm, X,Y, and Z direction for 2 hours				
Shock resistance		1,000 %, X,Y,Z each axis 3 times				
Storage Temperature		-30 ~ 90 °C				
Ambient Temperature		-5 ~ 40 °C (But without frostiness)				
Ambient Humidity		45 ~ 85 % RH				
Pollution level grade		2level pollution				
Usage		Resistive load / Inductive load				
Accepted standard		IEC 62314				
Weight		Approx. 227g				

Solid State Relay

■ AC input – AC load

Model		Low	SSR-3A102Z	SSR-3A202Z	SSR-3A302Z	SSR-3A402Z
		High	SSR-3A104Z	SSR-3A204Z	SSR-3A304Z	SSR-3A404Z
Appearance						
W X H X D (mm)		109 X 60 X 31,25				
LOAD	Rated Load Voltage	Low	90 – 264 V a.c.			
		High	90 – 480 V a.c.			
	Peak Voltage (Non-repetition)	Low	600 V			
		High	800 V	1,200 V		
	Rated load current		10 A	20 A	30 A	40 A
	Frequency		50/60 Hz (Dual usage)			
	Surge current (8.3 ms No repetition)	Low	170 A	260 A	420 A	
		High	170 A	250 A	370 A	
	Leakage current		20 mA max			
	Output ON voltage dropping		Less than 1.6 V (RMS)			
INPUT	Rated Voltage		100 – 240 V a.c.			
	Operating Voltage Range		70 – 264 V a.c.			
	Impedance		Less than 40 kΩ			
	Operation Voltage		more than 70 V a.c.			
	Input Current		220 V a.c. : 8 mA			
Response Time		1/2 Cycle + 1 ms max. ("R" type below 1 ms)				
Insulating Resistance		500 V d.c., 100 MΩ (Between the input / output and case)				
Dielectric strength		3,000 V a.c. (For 1 min at 60 Hz)				
Vibration resistance		10 – 55 Hz, Double amplitude : 1.5 mm, X,Y, and Z direction for 2 hours				
Shock resistance		1,000 ㎎, X,Y,Z each axis 3 times				
Storage Temperature		-30 ~ 90 °C				
Ambient Temperature		-5 ~ 40 °C (But without frostiness)				
Ambient Humidity		45 ~ 85 % RH				
Pollution level grade		2level pollution				
Usage		Resistive load / Inductive load				
Accepted standard		IEC 62314				
Weight		Approx. 227 g				

■ Suffix code

Model	Code	Information
SSR-3	<input type="checkbox"/> <input type="checkbox"/> <input type="checkbox"/> <input type="checkbox"/> <input type="checkbox"/>	3-Phase Solid State Relay
Input Control Voltage	D	5 – 24 V d.c.
	A	100 – 240 V a.c.
Rated load current	10	10 A
	20	20 A
	30	30 A
	40	40 A
Rated load voltage	2	90 – 264 V a.c. (Low)
	4	90 – 480 V a.c. (High)
Operation method	Z	Zero Cross Switching (Standard product)
	R	Random Switching

Solid State Relay

■ HSR-3 series 3-phase solid state relay

■ DC input – AC load (Low voltage : 90 – 264 V a.c.)

Model	HSR-3D102□	HSR-3D202□	HSR-3D302□	HSR-3D402□	HSR-3D502□	HSR-3D702□	
Appearance							
W X H X D (mm)	109 X 75 X 36						
Input	Rated voltage	5 – 24 V d.c.					
	Voltage use range	4 – 32 V d.c.					
	Impedance	Less than 4 kΩ					
	Operating voltage	More than 3 V d.c.					
	Release voltage	Less than 1.4 V d.c.					
Load	Rated load voltage	100 – 240 V a.c.					
	Load voltage range	90 – 264 V a.c.					
	Rated load current	10 A	20 A	30 A	40 A	50 A	70 A
	Input current	125 A	260 A	315 A		580 A	
	Output voltage drop	1.5 V	1.8 V				
Leakage current	1.5 mA	below 1.8 mA				15 mA	
Net weight	Approx. 400 g (Including packing box)						

■ AC input – AC load (Low voltage : 90 – 264 V a.c.)

Model	HSR-3A102□	HSR-3A202□	HSR-3A302□	HSR-3A402□	HSR-3A502□	HSR-3A702□	
Appearance							
W X H X D (mm)	109 X 75 X 36						
Input	Rated voltage	100 – 240 V a.c.					
	Voltage use range	90 – 264 V a.c.					
	Impedance	Less than 40 kΩ					
	Operating voltage	More than 72 V a.c.					
	Release voltage	Less than 50 V a.c.					
Load	Rated load voltage	100 – 240 V a.c.					
	Load voltage range	90 – 264 V a.c.					
	Rated load current	10 A	20 A	30 A	40 A	50 A	70 A
	Input current	125 A	260 A	315 A		580 A	
	Output voltage drop	1.3 V	1.6 V	1.8 V			
Leakage current	20 mA				15 mA		
Net weight	Approx. 400 g (Including packing box)						

■ DC input – AC load (High voltage : 90 – 480 V a.c.)

Model	HSR-3D104□	HSR-3D204□	HSR-3D304□	HSR-3D404□	HSR-3D504□	HSR-3D704□	
Appearance							
W X H X D (mm)	109 X 75 X 36						
Input	Rated voltage	5 – 24 V d.c.					
	Voltage use range	4 – 32 V d.c.					
	Impedance	Less than 4 kΩ					
	Operating voltage	More than 3 V d.c.					
	Release voltage	Less than 1.4 V d.c.					
Load	Rated load voltage	100 – 440 V a.c.					
	Load voltage range	90 – 480 V a.c.					
	Rated load current	10 A	20 A	30 A	40 A	50 A	70 A
	Input current	170 A	250 A	315 A		580 A	
	Output voltage drop	1.95 V	1.8 V	1.8 V			
Leakage current	below 20 mA						
Net weight	Approx. 400 g (Including packing box)				approx. 2000 g	approx. 2600 g	

Solid State Relay

■ AC input – AC load (High voltage : 90 – 480 V a.c.)

Model	HSR-3A104□	HSR-3A204□	HSR-3A304□	HSR-3A404□	HSR-3A504□	HSR-3A704□	
Appearance							
W X H X D (mm)	109 X 75 X 36						
Input	Rated voltage	100 – 240 V d.c.					
	Voltage use range	90 – 264 V d.c.					
	Impedance	Less than 72 kΩ					
	Operating voltage	More than 75 V a.c.					
	Release voltage	Less than 40 V a.c.					
Load	Rated load voltage	100 – 440 V a.c.					
	Load voltage range	90 – 480 V a.c.					
	Rated load current	10 A	20 A	30 A	40 A	50 A	70 A
	Input current	170 A	250 A	350 A	370 A	580 A	
	Output voltage drop	1.95 V	1.8 V				
Leakage current	below 20 mA						
Net weight	Approx. 400 g (Including packing box)				approx. 2000 g (including packing box)	approx. 2600 g (including packing box)	

■ General specification

Insulation resistance	500 V d.c. 100 MΩ (Between I/O and case)
Dielectric strength	2,500 V a.c. (1minute at 60 Hz)
Vibration resistance	10 – 55 Hz Double amplitude width 1.5 mm/ X,Y,Z each direction for 2 hours
Shock resistance	1,000 ㎥ X,Y,Z each axis 3 times
Storage temperature	-30 ~ 90 °C
Ambient temperature	-20 ~ 80 °C
Ambient humidity	45 ~ 85 % RH

Suffix code

Model	Code	Information
HSR-2	□ □ □ □ □	3-phase solid state relay
Input voltage	D	4 – 32 V d.c.
	A	90 – 264 V a.c.
Rated load current	10	10 A
	20	20 A
	30	30 A
	40	40 A
	50	50 A
	70	70 A
Load voltage	2	90 – 264 V a.c. (low voltage)
	4	90 – 480 V a.c. (High voltage)
Operation method	Z	Zero cross switching (standard product)
	R	Random switching
Radiator attachment state	–	No indication (no radiator)
	T	Radiator in one body type (only with 50A and 70A)

(Note) Operation method Z: zero cross switching, R: random switching

Solid State Relay

■ HSR-SL series Slim type Single phase solid state relay

■ Specification

Model		Low	HSR-SLD102Z	HSR-SLD152Z	HSR-SLD252Z	HSR-SLD402Z
		High	HSR-SLD104Z	HSR-SLD154Z	HSR-SLD254Z	HSR-SLD404Z
Appearance						
W X H X D (mm)		CE	22.42 X 99 X 74	22.4 X 99 X 98.5		44.4 X 99 X 98.5
		S-MARK	-	22.4 X 99 X 98.5	44.4 X 99 X 98.5	85 X 114 X 118
LOAD	Rated Load Voltage	Low	90 - 264 V a.c.			
		High	90 - 480 V a.c.			
	Peak Voltage (Non-repetition)	Low	600 V			
		High	800 V			1,200 V
	Rated load current		10 A	15 A	25 A	40 A
	Frequency		50/60 Hz (Dual usage)			
	Surge current (8.3 ms No repetition)	Low	170 A		260 A	420 A
		High	170 A		250 A	370 A
Leakage current		20 mA max				
Output ON voltage dropping		Less than 1.6 V (R.M.S)				
INPUT	Rated Voltage		5 - 24 V d.c.			
	Operating Voltage Range		4 - 32 V d.c.			
	Impedance		Less than 4 kΩ			
	Operation Voltage		more than 3 V d.c.			
	Reset Voltage		Less than 1.5 V d.c.			
	Input Current		Constant-current system : 8 mA (±3)			
Response Time		1/2 Cycle + 1 ms max. ("R" type below 1 ms)				
Insulating Resistance		500 V d.c., 100 MΩ (Between the input / output and case)				
Dielectric strength		3,000 V a.c. (For 1 min at 60 Hz)				
Vibration resistance		10 - 55 Hz, Double amplitude : 1.5 mm, X,Y, and Z direction for 2 hours				
Shock resistance		1,000 %, X,Y,Z each axis 3 times				
Storage Temperature		-30 ~ 90 °C				
Ambient Temperature		-5 ~ 40 °C (But without frostiness)				
Ambient Humidity		45 ~ 85 % RH				
Pollution level grade		2level pollution				
Usage		Resistive load / Inductive load				
Accepted standard		IEC 62314				
Weight		Approx. 190 g	Approx. 230 g		Approx. 372 g	

■ Suffix code

Model	Code	Information
HSR-SL	□ □ □ □ □ □ □ □	Slim Type Single-Phase Solid State Relay
Input Control Voltage	D	4 - 32 V d.c.
Contact	-	1 contact (No mark)
	2C	2 contact (Only for 15 A)
Rated load current	10	10 A (Alarm type product on demand)
	15	15 A
	25	25 A
	40	40 A
Rated load voltage	2	90 - 264 V a.c. (Low)
	4	90 - 480 V a.c. (High)
Operation method	Z	Zero Cross Switching (Standard product)
	R	Random Switching
Option	AL	Heat sink overheating 80 °C (For 10 A)

※ 2 contact : Only available for 15 A items (HSR-SLD2C152Z, HSR-SLD2C154Z)

※ Heat sink overheating (80 °C) alarm type is available for the 10 A product with low/high voltage (HSR-SLD102Z-AL, HSR-SLD104Z-AL)

Solid State Relay

■ HSR-2SL series Slim type Single phase solid state relay

■ Specification

Model		Low	HSR-2SE252Z	HSR-2SLD252Z	HSR-2SLD402Z
		High	HSR-2SE254Z	HSR-2SLD254Z	HSR-2SLD404Z
Appearance					
W X H X D (mm)		58 X 96.6 X 130		79 X 96.6 X 131.3	95 X 96.6 X 156.7
Load	Rated Load Voltage	Low	90 – 264 V a.c.		
		High	90 – 480 V a.c.		
	Peak Voltage (Non-repetition)	Low	600 V		
		High	1,200 V		
	Rated load current		25 A		40 A
	Frequency		50/60 Hz (Dual usage)		
	Surge current (8.3 ms No repetition)	Low	260 A		420 A
		High	250 A		370 A
Leakage current		Less than 10 mA			
Output ON voltage dropping		Less than 1.8 V (RMS)			
Rated impulse withstand voltage	Low	4 kV			
	High	6 kV			
Input	Rated Voltage		5 – 24 V d.c.		
	Operating Voltage Range		4 – 32 V d.c.		
	Impedance		Less than 4 kΩ		
	Operation Voltage		More than 3 V d.c.		
	Reset Voltage		Less than 1.5 V d.c.		
	Input Current		Constant-current system : 10 mA (±3)		
Detection parts	Rated Voltage		24 V d.c.		
	Operating Voltage Range		20 – 26 V d.c.		
	Power consumption		Max 25 mA, Max 40 mA in case of Alarm output (Base on 24 V d.c.)		
	Collector pressure		Less than 30 V d.c.		
	Maximum rated through current		Less than 50 mA		
	Max. collector power consumption		500 mW		
Output type		Transistor open collector (Hi at detection of problem)			
Response Time		1/2 Cycle + 1 ms max. ("R" type below 1 ms)			
Insulating Resistance		500 V d.c., 100 MΩ (Between the input / output and case)			
Dielectric strength		2,500 V a.c. (For 1 min at 60 Hz)			
Vibration resistance		10 – 55 Hz, Double amplitude : 1.5 mm, X,Y, and Z direction for 2 hours			
Shock resistance		1,000 %, X,Y,Z each axis 3 times			
Storage Temperature		-30 ~ 90 °C			
Ambient Temperature		-20 ~ 80 °C (But without frostiness)			
Ambient Humidity		45 ~ 85 % RH			
Pollution level grade		2level pollution			
Degree of protection		IP20			
Usage		Resistive load / Inductive load			
Accepted standard		IEC 62314			
Weight		Approx. 1,000 g		Approx. 1,300 g	

■ Suffix code

Model	Code	Information
HSR-2SLD	<input type="checkbox"/> <input type="checkbox"/> <input type="checkbox"/>	2 wire breaking alarm output contactless relay (Alarm open collector output)
HSR-2SE		2-wire isolated low-cost solid state relay (Alarm bimetallic contact output)
Rated load current	25	25 A
	40	40 A
Rated load voltage	2	90 – 264 V a.c. (Low)
	4	90 – 480 V a.c. (High)
Operation method	Z	Zero Cross Switching (Standard product)
	R	Random Switching

Solid State Relay

■ HSR-3SL series Slim Type 3-Phase Solid State Relay



Specification

Model	Low	HSR-3SLD152Z	HSR-3SLD252Z	HSR-3SLD402Z	
	High	HSR-3SLD154Z	HSR-3SLD254Z	HSR-3SLD404Z	
Appearance					
W X H X D (mm)	79 X 96,6 X 120			95 X 96,6 X 146	
LOAD	Rated Load Voltage	Low	90 – 264 V a.c.		
		High	90 – 480 V a.c.		
	Peak Voltage (Non-repetition)	Low	600 V		
		High	800 V	1,200 V	
	Rated load current	15 A (40 °C)	25 A (25 °C)	40 A (25 °C)	
	Frequency	50/60 Hz (Dual usage)			
	Surge current (8,3 ms No repetition)	Low	170 A	260 A	420 A
		High	170 A	250 A	370 A
	Leakage current	20 mA max			
	Output ON voltage dropping	Less than 1.6 V (RMS)			
INPUT	Rated Voltage	5 – 24 V d.c.			
	Operating Voltage Range	4 – 32 V d.c.			
	Impedance	Less than 4 kΩ			
	Operation Voltage	More than 3 V d.c.			
	Reset Voltage	Less than 1.5 V d.c.			
	Input Current	Constant-current system : 10 mA (±3)			
Response Time	1/2 Cycle + 1 ms max. ("R" type below 1 ms)				
Insulating Resistance	500 V d.c., 100 MΩ (Between the input / output and case)				
Dielectric strength	3,000 V a.c. (For 1 min at 60 Hz)				
Vibration resistance	10 – 55 Hz, Double amplitude : 1.5 mm, X,Y, and Z direction for 2 hours				
Shock resistance	1,000 %, X,Y,Z each axis 3 times				
Storage Temperature	-30 ~ 90 °C				
Ambient Temperature	-20 ~ 80 °C (But without frostiness)				
Ambient Humidity	45 ~ 85 % RH				
Weight	Approx. 1,000 g			Approx. 1,300 g	

Suffix code





Model	Code	Information
HSR-3SL	<input type="checkbox"/> <input type="checkbox"/> <input type="checkbox"/> <input type="checkbox"/>	Slim Type 3-Phase Solid State Relay
Input Control Voltage	D	4 – 32 V d.c.
Rated load current	15	15 A
	25	25 A
	40	40 A
Rated load voltage	2	90 – 264 V a.c. (Low voltage)
	4	90 – 480 V a.c. (High voltage)
Operation method	Z	Zero Cross Switching (Standard product)
	R	Random Switching





■ HEATSINK (HSP series / HSM series)

Model	HSP-10	HSP-20	HSP-40	HSM-70	HSM-110	HSM-150	HSM-200	HSM-250
		HSR-2□10□□	HSR-2□20□□	HSR-2□30□□ HSR-2□40□□	HSR-2□10□□	HSR-2□20□□ HSR-2□30□□	HSR-2□40□□ HSR-3□10□□	HSR-3□20□□ HSR-3□30□□
Appearance								
Capacity	10 A	20 A	30 A 40 A	10 A	20 A 30 A	40 A 10 A	20 A 30 A	40 A
length	48 mm	80 mm	109 mm	70 mm	110 mm	150 mm	200 mm	250 mm

DPS series Power Supply

Specification

Model	DPS-15S	DPS-30S	DPS-50S	DPS-75S
Appearance				
Dimension (mm)	25 X 90 X 103	40 X 90 X 103	40 X 90 X 103	56 X 124 X 97.8
Power output	15 W	30 W	50 W	75 W
Input voltage	100 - 240 V a.c. (* Designed voltage range : 85 - 264 V a.c.)			
Output voltage	5 V, 12 V, 15 V, 24 V			12 V, 24 V, 48 V
Voltage fluctuation range	±5 ~ 10 % (Varies due to the internal VR)			
Protective circuit	Over voltage, Over current, Over heat, Short circuit			
Dielectric strength	2,700 V a.c. for 1 minute (Between the input terminal and output terminal)			
Insulation resistance	100 MΩ min, 500 V d.c. (Between the input terminal and output terminal)			

Model	DPS-100S	DPS-120S	DPS-180S	DPS-240S
Appearance				
Dimension (mm)	56 X 124 X 97.8	66 X 124 X 97.8	66 X 124 X 97.8	125.5 X 124 X 97.8
Power output	100 W	120 W	180 W	240 W (* But, DPS-240S-12 : 216 W)
Input voltage	100 - 240 V a.c. (85 - 264 V a.c.)	100 - 120 V a.c. / 200 - 240 V a.c. * Auto-select input		
Output voltage	12 V, 24 V, 48 V		24 V, 48 V	
Voltage fluctuation range	±5 ~ 10 % (Varies due to the internal VR)			
Protective circuit	Over voltage, Over current, Over heat, Short circuit			
Dielectric strength	2,700 V a.c. for 1 minute (Between the input terminal and output terminal)			
Insulation resistance	100 MΩ min, 500 V DC (Between the input terminal and output terminal)			







Suffix code







Model	Code	Information
DPS-	<input type="checkbox"/> <input type="checkbox"/> <input type="checkbox"/>	DPS Power supply (DIN Rail Type)
Power output	15	15 W
	30	30 W
	50	50 W
	75	75 W
	100	100 W
	120	120 W
	180	180 W
Number of output voltage	S	1 Output (Single output)
	05	5 V d.c. (DPS-75S, DPS-100S, DPS-120S, DPS-180S, DPS-240S Exclude)
Output voltage classification	12	12 V d.c. (DPS-180S Exclude)
	15	15 V d.c. (DPS-75S, DPS-100S, DPS-120S, DPS-180S, DPS-240S Exclude)
	24	24 V d.c.
	48	48 V d.c. (DPS-15S, DPS-30S, DPS-50S Exclude)

Power Supply







TPS series Power Supply

Specification

Model	TPS-15S	TPS-30S	TPS-50S	TPS-55T	TPS-75S	TPS-100S
Appearance						
Dimension (mm)	64.1 X 97.5 X 32	79 X 98 X 37	83 X 125 X 39.8	83 X 125 X 39.8	83 X 125 X 39.8	93 X 199 X 50
Power output	15 W	30 W	50 W	55 W	75 W	100 W
Input voltage	100 – 240 V a.c. (* Designed voltage range : 88 – 264 V a.c.)					100 – 120 / 200 – 240 V a.c. (50 – 60Hz)
Output voltage	5 V, 12 V, 15 V, 24 V			A, B, C	5 V, 12 V, 15 V, 24 V	
Voltage fluctuation range	±5 ~ ±10 % (Varies due to the internal VR)					
Protective circuit	Over current, Over voltage, Over heat, Short circuit					
Dielectric strength	2,700 V a.c. for 1 minute (Between the input terminal and output terminal)					
Insulation resistance	100 MΩ min, 500 V d.c. (Between the input terminal and output terminal)					

Model	TPS-150S	TPS-220S	TPS-350S	TPS-450S	TPS-30D	TPS-50D
Appearance						
Dimension (mm)	93 X 209 X 65	93 X 209 X 65	115 X 230 X 50	115 X 230 X 50	83 X 125 X 39.8	96 X 135 X 40.2
Power output	150 W	220 W	350 W	450 W	30 W	50 W
Input voltage	100 – 120 / 200 – 240 V a.c. (50 – 60Hz)			100 – 240 V a.c. (* Designed voltage range : 88 – 264 V a.c.)		
Output voltage	5 V, 12 V, 15 V, 24 V	12 V, 15 V, 24 V	12 V, 24 V, 48 V	12 V, 24 V, 48 V	24/05 V, 24/12 V, 24/24 V	
Voltage fluctuation range	±5 ~ ±10 % (Varies due to the internal VR)					
Protective circuit	Over current, Over voltage, Over heat, Short circuit					
Dielectric strength	2,700 V a.c. for 1 minute (Between the input terminal and output terminal)					
Insulation resistance	100 MΩ min, 500 V d.c. (Between the input terminal and output terminal)					

Power Supply

Model	TPS-75D	TPS-230D	EPS-15S	EPS-30S	EPS-50S	EPS-150S
Appearance						
Dimension (mm)	83 X 125 X 39.8	115 X 230 X 50	64.1 X 97.5 X 32	79 X 98 X 37	83 X 125 X 39.8	93 X 199 X 50
Power output	75 W	230 W	15 W	30 W	50 W	150 W
Input voltage	100 - 240 V a.c. (* Designed voltage range : 88 - 264 V a.c.)	100 - 120 / 200 - 240 V a.c. (50 - 60Hz)	100 - 240 V a.c. (* Designed voltage range : 88 - 264 V a.c.)			100 - 120 / 200 - 240 V a.c. (50 - 60Hz)
Output voltage	24/05V, 24/12 V, 24/24 V	24/05 V, 24/12 V	5 V, 12 V, 15 V, 24 V, 48 V			12 V, 24 V, 48 V
Voltage fluctuation range	±5 ~ ±10 % (Varies due to the internal VR)					
Protective circuit	Over current, Over voltage, Over heat, Short circuit					
Dielectric strength	2,700 V a.c. for 1 minute (Between the input terminal and output terminal)					
Insulation resistance	100 MΩ min, 500 V d.c. (Between the input terminal and output terminal)					

Suffix code

TPS series

Model	Code	Information
TPS-	<input type="checkbox"/> <input type="checkbox"/> - <input type="checkbox"/>	TPS Power supply (Enclosed Type)
Power output	15	15W, 30W, 50W, 55W, 75W, 100W, 150W, 220W, 230W, 350W, 450W
Number of output voltage	S	1 Output
	D	2 Output (Only for 30W, 50W, 75W, 230W)
	T	3 Output (Only for 55W)
Output voltage classification	5	5 V d.c. (220W, 350W, 450W Exclude)
	12	12 V d.c.
	15	15 V d.c. (350W, 450W Exclude)
	24	24 V d.c.
	48	48 V d.c. (15W, 30W, 50W, 75W, 100W, 150W, 220W Exclude)
	2405	Output 1 : 24 V d.c. / Output 2 : 5 V d.c.
	2412	Output 1 : 24 V d.c. / Output 2 : 12 V d.c.
	2424	Output 1 : 24 V d.c. / Output 2 : 24 V d.c. (230W Exclude)
Output voltage classification	A	Output 1 : 5 V d.c. / Output 2 : 12 V d.c. / Output 3 : -5 V d.c.
	B	Output 1 : 5 V d.c. / Output 2 : 12 V d.c. / Output 3 : -12 V d.c.
	C	Output 1 : 5 V d.c. / Output 2 : 15 V d.c. / Output 3 : -15 V d.c.

EPS series (Economy)

Model	Code	Information
EPS-	<input type="checkbox"/> <input type="checkbox"/> - <input type="checkbox"/>	EPS Power supply (Enclosed Type)
Power output	15	15W, 30W, 50W, 150W
Number of output voltage	S	1 Output
Output voltage classification	5	5 V d.c.(150W Exclude)
	12	12 V d.c.
	15	15 V d.c. (150W Exclude)
	24	24 V d.c.
	48	48 V d.c.

Temperature Controller
Recorder
Digital Counter
Timer
Analog Timer
Panel Meter
Multi Pulse Meter
Proximity Sensor
Photo Sensor
Rotary Encoder
Thyristor Power Regulator
Solid State Relay
Power Supply
Control Switch
Push Button / Main Switch
Cam Switch / Limit Switch
Micro / Hoist Switch
Foot / Mono Lever Switch
Signal Light
Terminal Block / Power Buzzer / Fuse Holder / Control Box

Control Switch

MR series (Aluminum guard type)







Model	PUSH-BUTTON SWITCH					
	Aluminum guard type			Plastic guard type		
	Flush Ø30	Flush Ø25	Extended Ø22	Flush Ø25	Extended Ø22	
Appearance						
Suffix code	MRF-A(Ø30)	MRF-N(Ø25)	MRF-R(Ø22)	MRF-K(Ø25)	MRF-T(Ø22)	
Model	ILLUMINATED PUSH BUTTON SWITCH					
	Aluminum guard type			Plastic guard type		
	Flush Ø30	Flush Ø25	Extended Ø22	Flush Ø25	Extended Ø22	ON / OFF
Appearance						
Suffix code	MRX-A(Ø30)	MRX-N(Ø25)	MRX-R(Ø22)	MRX-K(Ø25)	MRX-T(Ø22)	MRX-WM2
Model	PILOT LAMP					
	Aluminum guard type			Plastic guard type		
	Flush Ø30	Flush Ø25	Extended Ø22	Flush Ø25	Extended Ø22	
Appearance						
Suffix code	MRP-A(Ø30)	MRP-N(Ø25)	MRP-R(Ø22)	MRP-K(Ø25)	MRP-T(Ø22)	
Model	SELECTOR SWITCH					
	Aluminum guard type			Plastic guard type		
	Flush Ø30	Flush Ø25	Extended Ø22	Flush Ø25	Extended Ø22	
Appearance						
Suffix code	MRS-A(Ø30)	MRS-N(Ø25)	MRS-R(Ø22)	MRS-K(Ø25)	MRS-T(Ø22)	
Model	ILLUMINATED SELECTOR SWITCH					
	Aluminum guard type			Plastic guard type		
	Flush Ø30	Flush Ø25	Extended Ø22	Flush Ø25	Extended Ø22	
Appearance						
Suffix code	MRT-A(Ø30)	MRT-N(Ø25)	MRT-R(Ø22)	MRT-K(Ø25)	MRT-T(Ø22)	
Model	KEY SELECTOR SWITCH					
	Aluminum guard type		Plastic guard type			
	Flush Ø30	Flush Ø25	Extended Ø22			
Appearance						
Suffix code	MRK-A(Ø30)	MRK-N(Ø25)	MRK-R(Ø22)			





Control Switch

Model		EMERGENCY STOP BUTTON SWITCH				
		Aluminum guard type			Plastic guard type	
		Flush Ø30	Flush Ø25	Extended Ø22	Flush Ø25	Extended Ø22
Appearance						Temperature Controller
Suffix code	MRE-AM(Ø30)	MRE-NM(Ø25)	MRE-RM(Ø22)	MRE-KM(Ø25)	MRE-TM(Ø22)	Recorder
Appearance						Digital Counter
Suffix code	MRE-AR(Ø30)	MRE-NR(Ø25)	MRE-RR(Ø22)	MRE-KR(Ø25)	MRE-TR(Ø22)	Timer
Appearance						Analog Timer
Suffix code	MRE-AR(Ø30)	MRE-NR(Ø25)	MRE-RR(Ø22)	MRE-KR(Ø25)	MRE-TR(Ø22)	Panel Meter
Model		ILLUMINATED EMERGENCY STOP BUTTON SWITCH				
		Aluminum guard type			Plastic guard type	
		Flush Ø30	Flush Ø25	Extended Ø22	Flush Ø25	Extended Ø22
Appearance						Multi Pulse Meter
Suffix code	MRA-AM(Ø30)	MRA-NM(Ø25)	MRA-RM(Ø22)	MRA-KM(Ø25)	MRA-TM(Ø22)	Proximity Sensor
Appearance						Photo Sensor
Suffix code	MRA-AR(Ø30)	MRA-NR(Ø25)	MRA-RR(Ø22)	MRA-KR(Ø25)	MRA-TR(Ø22)	Rotary Encoder
Appearance						Thyristor Power Regulator
Suffix code	MRA-AR(Ø30)	MRA-NR(Ø25)	MRA-RR(Ø22)	MRA-KR(Ø25)	MRA-TR(Ø22)	Solid State Relay
Model		BUZZER				
		Aluminum guard type			Plastic guard type	
		Flush Ø30	Flush Ø25	Extended Ø22	Flush Ø25	Extended Ø22
Appearance						Power Supply
Suffix code	MRB-A(Ø30)	MRB-N(Ø25)	MRB-R(Ø22)	MRB-K(Ø25)	MRB-T(Ø22)	Control Switch
Contact unit	MR-CB					Push Button /
Contact configuration	1a1b					Main
Operation of contact	Snap-action					Switch
Installing panel thickness	7.0 mm (When excluded the additional accessories)					Cam Switch /
	Plastic guard extended type : 7 mm (when excluded the additional accessories)					
Material	Contact material	AgSnO2				Switch
	Contact cover material	Polycarbonate (PC)				
	Contact body material	Polycarbonate (PC)				
Mechanical characteristic	Fixed torque	Installing screw : 1.96 N·m max, Terminal screw : 0.78 N·m max				Micro /
	Operating distance	5 mm ±0.2				Hoist
	Reflection time	max 3 ms				Switch
	Durability of actuator	Button : min 1 million times, Selector switch : min 50 thousand times				Foot /
Electrical characteristic	Dielectric strength	2,000 V a.c. for 1 min				Mono Lever
	Contact resistance	Max 50 mΩ (Default)				
	Insulation resistance	Min 100 MΩ 500 V d.c				Signal
	Switch rating	AC : 6 A 250 V a.c., DC : 10 A 24 V d.c.				
	Min load current	5 mA 24 V d.c., 10 mA 110 V d.c.				
Electrical durability	500 thousand times (resistive load)				Light	
Light source	Power supply voltage	100 - 240 V a.c. (LED condenser voltage dropping type)				Terminal Block /
		380 V a.c. (LED condenser voltage dropping type)				
		12 - 24 V d.c./a.c. (LED Resistance voltage dropping type)				
Environment condition	Ambient temperature	-20 ~ 55 °C				Power Buzzer / Fuse Holder / Control Box
	Ambient humidity	35 ~ 85 % RH				
	Storage temperature	-40 ~ 85 °C				
	Shock resistance	300 % pulse cycle 11 ms				
	Vibration resistance	100 %, 10 Hz - 55 Hz, amplitude 0.75 mm (within 1 ms)				

Control Switch

■ AR series  

Model	PUSH-BUTTON SWITCH		ILLUMINATED PUSH-BUTTON SWITCH		PILOT LAMP	
	Round	Round	Round	ON / OFF	AC	DC
Appearance						
Suffix code	ARF-F,B,P,G,H	ARF-S	ARX-P,G,H	ARX-S	ARP-A1,A2	ARP-B12,B24

Model	SELECTOR SWITCH	ILLUMINATED SELECTOR SWITCH	PILOT WHOLLY TYPE	EMERGENCY PUSH-BUTTON SWITCH	
	Lever	Lever			
Appearance					
Suffix code	ARS-S	ART	ARK	ARE-B,P,R,K	ARE-4XR

Operation	Mechanical	Max. 30 Operations /minute
	Electrical	Max. 30 Operations /minute
Insulation resistance		Min.100 MΩ (AT 500 V d.c.)
Dielectric strength		1,500 V a.c. 50/60 Hz for minute
Vibration	Malfunction Resistance	10 – 55 Hz double amplitude width 3 mm
Shock	Mechanical Durability	Min.500 %
	Malfunction Resistance	Min.100 %
Life	Mechanical	Min. 0.5 millions operations, 1,000 hour (PILOT LAMP)
	Electrical	Min. 0.1 millions operations, 1,000 hour (PILOT LAMP)
Ambient temperature		-25 ~ 40 °C
Ambient humidity		45 ~ 85 % RH
Storage temperature		-40 ~ 70°C

● LAMP RATINGS

Rated voltage		Rated current		Consumption power	
Incandescent light lamp	LED LAMP	Incandescent light lamp	LED LAMP	Incandescent light lamp	LED LAMP
6.3 V	6 V	150 mA	72 mA	1 W	0.4 W
12 V	12 V	80 mA	36 mA	1 W	0.4 W
24 V	24 V	40 mA	18 mA	1 W	0.4 W

● TRANSFORMER RATINGS

Rated voltage	Voltage use	Lamp
110 V a.c.	110 V a.c.	150 mA, 6.3 V a.c. LAMP
220 V a.c.	220 V a.c.	

※ LED lamp switch using transformer is on order made product. Contact block rated is 6 A 250 V a.c.

Control Switch



■ CR series (Control switch)

Suffix code		Power voltage	Current consumption	Diameter	Remarks
 Push Button Lamp Switch	CR-254	100 – 240 V a.c.	4.4 VA max	Ø25	Red, Green, Blue, Yellow, White
	CR-304	380 V a.c.	2.7 VA max	Ø30	
		12 – 24 V d.c.	18 mA max		
 Push Button Switch	CR-251	5 A, 250 V a.c.	–	Ø25	Red, Green, Blue, Yellow, Black
	CR-301			Ø30	
 Pilot Lamp	CR-252	100 – 240 V a.c.	4.4 VA max	Ø25	Red, Green, Blue, Yellow, White
	CR-302	380 V a.c.	2.7 VA max	Ø30	
		12 – 24 V d.c.	18 mA max		
 Selector Switch	CR-253	5 A, 250 V a.c.	–	Ø25	–
	CR-303			Ø30	
 Emergency Stop Button Switch	CR-257	5 A, 250 V a.c.	–	Ø25	Red, Green, Yellow
	CR-307			Ø30	
 Emergency Stop Button Switch (Push lock turn reset)	CR-257R	5 A, 250 V a.c.	–	Ø25	Red, Green
	CR-307R			Ø30	
 Selector Push Button Switch	CR-308	5 A, 250 V a.c.	–	Ø30	Contact 1a1b
 Key Switch	CR-2511	5 A, 250 V a.c.	–	Ø25	–
	CR-3011			Ø30	

- Temperature Controller
- Recorder
- Digital Counter
- Timer
- Analog Timer
- Panel Meter
- Multi Pulse Meter
- Proximity Sensor
- Photo Sensor
- Rotary Encoder
- Thyristor Power Regulator
- Solid State Relay
- Power Supply
- Control Switch
- Push Button / Main Switch
- Cam Switch / Limit Switch
- Micro / Hoist Switch
- Foot / Mono Lever Switch
- Signal Light
- Terminal Block / Power Buzzer / Fuse Holder / Control Box

Control Switch

SR series (Ø16 Small control switch) CE

Model	SRF	SRX	SRP	SRS	SRK	SRE
	PUSH-BUTTON	ILLUMINATED PUSH-BUTTON	PILOT-LAMP	SELECTOR	KEY-SELECTOR	EMERGENCY RESET
Appearance						
Ratings	5 A, 250 V a.c.					
Display color	Red, Yellow, Green, Blue, White					
Contact	AgNi					
Insulation resistance	Min.100 MΩ					
Dielectric strength	1500 V a.c. (50/60 Hz for 1min.)					
Vibration	10 – 55 Hz, Double amplitude 0.75 mm					
Operation	Mechanical	Min. 500,000 times		Min. 100,000 times		
	Electrical	Min. 70,000 times				
Ambient temperature	-20 ~ 50 °C					
Ambient humidity	45 ~ 88 % RH					
Storage temperature	-40 ~ 70 °C					

INCANDESCENT LAMP RATINGS

Power voltage	Power consumption
6.3 V a.c. / d.c.	60 mA
6.3 V a.c. / d.c.	40 mA
6.3 V a.c. / d.c.	20 mA

LED RATINGS

Power voltage	Power consumption
12 V a.c. / d.c.	20 mA
24 V a.c. / d.c.	15 mA

CR40 series LED Rectangular lamp

Specification

Model	CR40		
Appearance			
Voltage	100 – 240 V a.c.	380 V a.c.	12 – 24 V d.c.
Current consumption	4.4 VA max	2.7 VA max	18 mA max
Cap color	Red, Yellow, Green, Blue, White		
Insulation resistance	Min. 100 MΩ (Within current carrying part & non current carrying part)		
Dielectric strength	1,500 V a.c. for 1 minute		
LED life	above 100,000 Hours		
Ambient temperature	-20 ~ 40 °C		
Ambient humidity	45 ~ 85 % RH		
Storage temperature	-25 ~ 55 °C		

Suffix code

Model	Code	Information	
CR40	<input type="checkbox"/> <input type="checkbox"/>	CR40 series, LED indicator	
Power supply voltage	A0	110 – 240 V a.c.	LED (Condenser voltage dropping type)
	A3	380 V a.c.	
	D0	12 – 24 V d.c.	LED (Resistance voltage dropping type)
Color of indicator	R	Red, Yellow, Green, Blue, White	

Combination Display Lights

CD series LED Combination display lights

Specification





Model	CD		
Appearance			
Voltage	24 V d.c.	110 / 220 V a.c.	110 / 125 V d.c.
Cap color	Red, Yellow, Green, White, Orange		
Insulation resistance	Min. 100 MΩ (At 500 V d.c.)		
Dielectric strength	1,500 V a.c. for 1minute		
Consumption power	0.68 W(24 V d.c., 28 mA)		
LED	24 V d.c.		
Life	50,000 hours (24 V d.c., 25 °C)		
Ambient temperature	-20 °C ~ 40 °C		
Ambient humidity	45 ~ 85 % RH		
Storage temperature	-25 ~ 55 °C		

※Note : CD-S□ (30 X 30 mm) and CD-R□ (30 X 40 mm)

Suffix code

Model	Code	Information	
CD	□ □ □ □	CD series Combination display lights	
Standard type	S	Square type (30 mm × 30 mm)	
	R	Rectangular type (30 mm × 40 mm)	
Power supply voltage	A	24 V a.c. / d.c.	Without voltage dropping
	B	100 ~ 125 V d.c.	Resistance voltage dropping type
	C	110 V a.c.	Condenser voltage dropping type
	D	220 V a.c.	
LED indicating color	R	Red	
	G	Green	
	Y	Yellow	
	W	White	
	O	Orange	
	A	Blue	
Surface composition	2	1 column ~ 10 column (height)	
	6	1 row ~ 20 rows (Width)	

HY-500 series Power button switch

Model	RATINGS	USE
 EXPOSURE HY-510	3P 250 V a.c. 15A	Electromotor 3 phase power supply ON, OFF
 BUILT-IN HY-512 HY-513 HY-514	2P 250 V a.c. 15A	1 phase Electromotor ON, OFF
	3P 250 V a.c. 15A	Electromotor for 3 phase power supply ON, OFF
	3P 250 V a.c. 15A	Electromotor for 3 phase power supply ON, OFF
 EXPOSURE HY-516	3P 250 V a.c. 15A	Electromotor for 3 phase power supply Direct/reverse revolution for stop 1 phase, 3 phase, right/left for revolution
 EXPOSURE HY-517	3P 250 V a.c. 15A	Electromotor 1 phase, 3 phase ON, OFF



Power Push Button Switch

■ BE series Power button switch

● STEEL CASE BE

Model	RATINGS	ELECTROMOTOR CAPACITY(KW)		CONTACT TERMINAL	LITERAL DISPLAY	MATERIAL OF CASE
		1Ø100/110V	3Ø200/220V			
 STEEL CASE EXPOSURE	BE 230	3P 30A	–	3.7	M5	ON(black) OFF(red) cold workable steel plate

● WATER PROOF (BEW, BEWT)

Model	RATINGS	ELECTROMOTOR CAPACITY(KW)		CONTACT TERMINAL	LITERAL DISPLAY	MATERIAL OF CASE
		1Ø100/110V	3Ø200/220V			
 WATER PROOF	BEW 215	3P 15A	0.4	2.2	M4	burning resist ABS
	BEW 230	3P 30A	–	3.7	M5	
 ADVANCED WATER PROOF	BEWT 215	3P 15A	0.4	2.2	M4	
	BEWT 315	3P 15A	0.4	2.2	M4	

■ MAS series Main switch

■ Specification

Appearance	Suffix code	Rated insulation voltage	Rated current	Material
	MAS-025-A/B	690 V a.c.	25 A	Anti-flammable
	MAS-063-A/B		63 A	
	MAS-125-A/B		125 A	

■ Suffix code

Model	Code	Information
MAS-	<input type="checkbox"/> <input type="checkbox"/>	Main Switch
Rated current	025	25 A a.c. ※IP64
	063	63 A a.c. ※IP55
	125	125 A a.c. ※IP65
Color classification	A	Emergency stop type (Yellow guard / Red handle)
	B	Standard type (White guard / Black handle)

■ HY-SQ5/255/305/MRK series Cam switch

■ Specification

Model		Square type	Round type	Handle control type	Circle type	Square key type		
Appearance								
Contact part	AC	Voltage					110 / 250 / 440 V	
		Rated current					10 / 7 / 3 A	
		Momentary current					closed momentary current = rated current×10	
	DC	Voltage					24 / 110 / 250 V	
		Resistance	Rated current					10 / 5 / 3 A
			Momentary current					closed momentary current=rated current×1.1
		Induction	Rated current					5 / 1 / 0.4 A
	Momentary current					closed momentary current=rated current×1.1		
	Rated electric current		10 A					
	Life	Mechanical		Min. 0.5 millions operations				
Electrical		Min. 0.1 millions operations						
Insulation resistance		Min. 100 MΩ						
Contact resistance		Max. 15 MΩ (Initial)						
Dielectric strength		1,500 V a.c. 1 minute						
Vibration resistance		10 – 55 Hz double amplitude width 1.5 mm						
Shock resistance		Min. 30G						
Operation power		560 g						
Ambient temperature		-20 ~ 50 °C						

■ Suffix code

Model	Code	Information
Appearance	<input type="checkbox"/> <input type="checkbox"/> <input type="checkbox"/> <input type="checkbox"/> <input type="checkbox"/> <input type="checkbox"/>	Cam switch
	HY-SQ5	Square type cam switch
	HY-255	∅ 25 type cam switch
	HY-305	∅ 30 type cam switch
Contact type	S	Square type (Standard type)
	C	Round type (for HY-SQ5)
Handle type	H	Standard type (Standard industrial machine)
	R	Switch-board type (A/S, V/S)
	P	Control switch type (C/S)
Notches selection	2	2 positions selection
	3	3 positions selection
	4	4 positions selection
	5	5 positions selection
	6	6 positions selection
Number of contact unit (Number of rows)	1	1 Row
	2	2 Rows
Serial number (Contact formation diagram)	01	Label the serial number of contact formation
	02	Diagram in case of order-made product

※ A/S : ammeter converting switch, V/S : voltmeter converting switch

※ Possible to manufacture 20 A, 250 V product only within the square type contact structure

Model	Code	Information
HY-MRK	4 2 0 2	KEY-CAM SWITCH
Contact formation		Labeled the serial number (Refer to the standard circuit diagram)

Cam Switch

SQ4 Cam switch

Specification

Model	SQ4	
Appearance		
Rated Insulation voltage (Ui)	690 V a.c.	
Dielectric strength (Uimp)	2,500 V a.c.	
Rated Electro Current (Ith)	16 A	
Rated Service Voltage (Ie)	16 A	
Rated Service Current (Ue)	480 V a.c.	
Mechanical Life Expectancy	300,000 Times	
Electrical Life Expectancy	AC : 200,000 Times, DC : 100,000 Times	
Ambient Temperature	-25 ~ 55 °C	
Ambient Humidity	Max 90 % RH	
Altitude	Max 2,000 m	
Protective Structure	IP65	
Pollution level	3	
Component Materials	Body	NY66 GF15 % Level of Resistance to flame
	Cam	ACETAL
	Contact	AgNi
	Terminal	Brass
	Bolt	Iron (Galvanizing)
	Spring	Stainless (STS)
	Handle	Level of PC Resistance to flame

Suffix code

Model	Code	Information
SQ4-	<input type="checkbox"/> <input type="checkbox"/> <input type="checkbox"/> <input type="checkbox"/> <input type="checkbox"/> <input type="checkbox"/> <input type="checkbox"/>	Cam switch
Installation	F	Four holes of panel mounting
Contact type	S	Square type (Standard type)
Handle type	H	Standard type (Standard industrial machine)
	R	Switch-board type (A/S, V/S)
Notches selection	2	2 positions selection
	3	3 positions selection
	4	4 positions selection
	5	5 positions selection
	6	6 positions selection
	7	7 positions selection
	Number of contact unit (Number of rows)	1
2		2 Rows
3		3 Rows
4		4 Rows
5		5 Rows
6		6 Rows
Serial number (Contact formation diagram)	0 1	Label the serial number of contact formation

※ In case of standard item, please check circuit diagram

LIMIT SWITCH CE

Model	ROLLER PLUNGER		TOP BALL PLUNGER		VARIABLE ROLLER LEVER		VARIABLE ROD		ROLLER LEVER		SPRING WIRE		FORK ROLLER LEVER	
	M902	LM902	M903	LM903	M904	LM904	M907	LM907	M908	LM908	M909	LM909	M908R	M908L
Appearance														
Operation speed	0.1 – 1 %													
Frequency	Mechanical	120 /minute												
	Electrical	20 /minute												
Insulation resistance	Min. 100 MΩ (At 500 V d.c.)													
Dielectric strength	1,000 V a.c. 50/60 Hz 1 minute (between charging part), 1,500 V a.c. 50/60 Hz 1 minute (between discharging part)													
Contact resistance	Max. 100 MΩ (initial)													
Vibration	Malfuction Resistance	10 – 55 Hz Double amplitude width 1.5 mm												
Shock	Mechanical Durability	Min. 1,000 % (Min. 100G)												
	Malfuction Resistance	Min. 300 % (Min. 30G)												
Life	Mechanical	Min. 1 Millions operations												
	Electrical	Min. 0.3 Million operation												

RATINGS

RATED VOLTAGE (V)	NON-INDUCTIVE LOAD(A)				INDUCTIVE LOAD(A)			
	Resistive LOAD		RAMP		INDUCTIVE LOAD		MOTOR LOAD	
	NC	NO	NC	NO	NC	NO	NC	NO
AC	125	15	3	1.5	10	3	1.5	
	250	10	2	1	6	2	1	
	480	3	1.5	0.8	2	1.5	0.75	
DC	8	15	6	3	10			
	14	15	6	3	10			
	30	6	4	3	5			
	125	0.4	0.2	0.2	0.05			
	250	0.2	0.1	0.1	0.03			

MINI LIMIT SWITCH







Model	Roller Plunger type	CrossRoller Plunger type	Top Plunger type	Roller Adjustable Lever	Rubber Roller Adjustable Lever	Adjustable Rod Lever	Roller Lever	Coil spring type
	HY-L802	HY-L802C	HY-L803	HY-L804	HY-L804RE	HY-L807	HY-L808	HY-L809
Appearance								
Frequency	Mechanical	120 /minute						
	Electrical	30 /minute						
Insulation resistance	Min. 100 MΩ (At 500 V d.c.)							
Dielectric strength	Between non-continuous terminal : 1500 V a.c. 50/60 Hz 1minute Between terminal & non-current carrying metal part : 2,000 V a.c. 50/60 Hz 1 minute							
Contact resistance	Max. 25 MΩ (initial), Max. 100 MΩ (after testing)							
Vibration	Malfuction Resistance	Min. 10 – 55 Hz double amplitude width 1.5 mm						
Shock	Mechanical Durability	Min. 300% (30G above)						
	Malfuction Resistance	Min. 100% (10G above)						
Life	Mechanical	Min. 1 million operation (Switching frequency 120 /minute)						
	Electrical	Min. 0.1 millions operations (Switching frequency 20 /minute, at rated load)						
Ambient temperature and humidity	-10 ~ 70 °C 95 % RH below (20 °C)							

RATINGS

RATED VOLTAGE	LOAD	Resistive LOAD (cosφ≒1)	INDUCTIVE (cosφ≒0.4)
	125 V a.c.		5 A
250 V a.c.		5 A	2 A
125 V d.c.		0.4 A	0.1 A

Limit Switch









N TYPE LIMIT SWITCH

Model		Roller Plunger	Push Plunger	Roller Arm	Rubber Roller Lever	Roller Adjustable Lever	Adjustable Rod Lever	Roller Lever
		LS-802N	LS-803N	LS-803RN	LS-804RE	LS-804N	LS-807N	LS-808N
Appearance								
Frequency	Mechanical	120 /minute						
	Electrical	30 /minute						
Insulation resistance		Min. 100 MΩ (AT 500 V d.c.)						
Contact resistance		Max. 25 MΩ (initial)						
Dielectric resistance		1,000 V a.c. 50/60 Hz for 1 minute, 2,000 V a.c. 50/60 Hz for 1 minute						
Vibration	Malfuction Resistance	10 – 55 Hz double amplitude width 1.5 mm						
Shock	Mechanical Durability	Min. 1,000 % (Min. 100G)						
	Malfuction Resistance	Min. 300 % (Min. 30G)						
Life	Mechanical	Min. 1 million operation						
	Electrical	Min. 0.1 million operation						
Ambient temperature		-10 ~ 70 °C						
Ambient humidity		Max. 95 % RH (20 °C)						

RATINGS

RATED VOLTAGE (V)		NON-INDUCTIVE Load(A)			INDUCTIVE LOAD(A)			
		Resistive LOAD		RAMP	INDUCTIVE LOAD		MOTOR LOAD	
		NO		NC	NO	NC	NO	NC
AC	125	6		2	6		3	
	250	6		1.5	6		1.5	
DC	8	6		4	6		4	
	14	6		4	6		4	
	30	4		2.5	4		2.5	
	125	0.4		0.1	0.4		0.1	
	250	0.2		0.05	0.2		0.05	

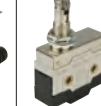
ZCN TYPE LIMIT SWITCH CE















Model		Plunger type	Hinge roller short lever type	Hinge roller long lever type	Hinge short lever type	Hinge lever type	Hinge long lever type	Vertical roller plunger type	Horizontal roller plunger type	Resin road spring type
		P501O	R504A	R504C	L507A	L507C	L507D	PR508V	PR508H	L509
Appearance										
Operation speed		0.1 mm – 0.5 %								
Frequency	Mechanical	120 /minute								
	Electrical	20 /minute								
Insulation resistance		Min. 100 MΩ (AT 500 V d.c.)								
Contact resistance		Max. 25 MΩ (initial), Max. 100 MΩ								
Dielectric strength		Between charging part : 1,000 V a.c. 50/60 Hz for 1 minute, Between discharging part : 1,500 V a.c. 50/60 Hz for 1 minute								
Vibration	Malfuction Resistance	10 – 55 Hz double amplitude width 1.5 mm								
Shock	Mechanical Durability	Min. 1,000 % (Min. 100G)								
	Malfuction Resistance	Min. 300 % (Min. 30G)								
Life	Mechanical	Min. 1 million operation								
	Electrical	Min. 0.3 million operation								
Ambient temperature and humidity		-10 ~ 80 °C Max. 25 ~ 95 % RH								

RATINGS

RATED VOLTAGE (V)		NON-INDUCTIVE LOAD(A)			INDUCTIVE LOAD(A)			
		Resistive LOAD		INDUCTIVE LOAD		MOTOR LOAD		
		N.C	N.O	N.C	N.O	N.C	N.O	
AC	125	15		10		3	1.5	
	250	10		6		2	1	
	600	3		2		1.5	0.75	
DC	8	15		10		-	-	
	14	15		10		-	-	
	30	6		5		-	-	
	125	0.4		0.05		-	-	
	250	0.2		0.03		-	-	

Micro Switch

MICRO SWITCH

Model	Panel mounting type	Spring single push button type	Pin push button type	Spring stander push button type	Hinge roller single lever type
	HY-P701A (Z4G1P05B)	HY-P701B (Z4G1P09B)	HY-P701C (Z4G1P01B)	HY-P701D (Z4G1P03B)	HY-R704A (Z4G1L07B)
Appearance					
Model	Hinge roller middle lever type HY-R704B	Hinge roller lever type HY-R704C (Z4G1L03B)	2 positions roller lever type HY-R704-2W	Single position lever type HY-L707A	Middle lever type HY-L707B
Appearance					
Model	Hinge lever type HY-L707C (Z4G1L01B)	Special lever type HY-L707D	Hinge special lever type HY-L707S	Roller panel mounting type (Vertical) HY-PR708A	Roller panel mounting type HY-PR708B (Z4G1P07B)
Appearance					
Operation speed	0.1 mm - 1 %				
Frequency	Mechanical	50 - 300 / minute			
	Electrical	20 / minute			
Insulation resistance	Min. 100 MΩ (AT 500 V d.c.)				
Contact resistance	Max. 50 MΩ (initial), Max. 2 Ω (after testing)				
Vibration resistance	10 - 55 Hz double amplitude 0.75mm				
Shock	Mechanical Durability	Min. 1000 % (Min. 100 G)			
	Malfunction Resistance	Min. 300 % (Min. 30 G)			
Dielectric strength	1,000 V a.c. 50/60 Hz for 1 minute (between charging part) 1,500 V a.c. 50/60 Hz for 1 minute (between discharging part)				
Life	Mechanical	Min. 1 Millions Operations (Switching frequency 120 / minute)			
	Electrical	Min. 0.3 Millions Operations (Switching frequency 20 / minute, at rated load)			
Net weight	31.5 ~ 59.5 g				
Rated current	10 A 250 V a.c. (Resistive load)				

Temperature Controller

Recorder

Digital Counter

Timer

Analog Timer

Panel Meter

Multi Pulse Meter

Proximity Sensor

Photo Sensor

Rotary Encoder

Thyristor

Power Regulator

Solid State Relay

Power Supply

Control Switch

Push Button / Main Switch

Cam Switch / Limit Switch

Micro / Hoist Switch

Foot / Mono Lever Switch









Signal Light

Terminal Block / Power Buzzer / Fuse Holder / Control Box

Foot Switch

■ HY-100 series Foot switch

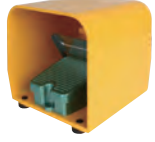
■ Specification





Model	HY-101		HY-102N			
Appearance						
Rated voltage	250 V a.c., 10 A		250 V a.c., 10 A			
Internal switch	SMV-61A-07H		SMV-61A-07H			
Material of case	ABS resin		AL Die-casting			
Model	HY-103N		HY-104		HY-105	
Appearance						
Rated voltage			250 V a.c., 10 A			
Internal switch	HY-P701B		HY-P701B		HY-P701B	
Material of case			AL Die-casting			

■ Suffix code

Model	Code	Information
HY-10	<input type="checkbox"/>	Foot Switch
Appearance	1	Plastic foot switch
	2N	Aluminum foot switch
	3N	Middle size aluminum foot switch
	4	Large size aluminum foot switch
	5	Large size aluminum foot switch

■ LEL/LES series Mono lever switch

■ Specification

Model		LONG LEVER		SHORT LEVER		
Appearance						
Contact part	AC	Rated voltage		150 V / 250 V / 600 V		
		Rated current		5 A / 3 A / 1 A		
		Cut-off current		Open circuit & Cut-off current=Rated current×10		
	DC	Rated voltage		125 V / 250 V		
		resistance	Rated current	2.2 A / 1.1 A		
			Cut-off current	Rated current×1.1		
		Induction	Rated current	1.2 A / 0.45 A		
	Cut-off current		Rated current×1.1			
	Rated electric current		10 A			
	Insulation resistance		Min. 100 Ω			
Dielectric strength		2,500 V a.c. / 1 minute between charging part & between discharging part				
Contact resistance		Max. 20 mΩ below				
Life		mechanical, Min. 0.5 millions operations , electrical: Min. 0.1millions operations				
Ambient temperature		-20 ~ 50 °C				

■ Suffix code

Model	Code	Information
LE	<input type="checkbox"/> <input type="checkbox"/> <input type="checkbox"/>	Mono lever switch
Lever selection	L	Long lever
	S	Short lever
Stage selection	01	Select 1 position
	02	Select 2 positions
	03	Select 3 positions
	04	Select 4 positions
Returning type	1	Auto returning
	2	Manual returning

■ HY-1020 series Hoist switch

■ Specification

Model	HY-1022 (2 BUTTON)	HY-1024 (4 BUTTON)	HY-1026 (6 BUTTON)	HY-1028 (8 BUTTON)	HY-1029 (10 BUTTON)
Appearance					
Protection construction	IP-66(IEC) (Excluding Emergency Switch Type)				
Material	Case	ABS			
	Screw	Cover Bolt (Stainless screw)			
Color	Button packing	Special rubber (black)			
	Cable bracket	Special rubber (black)			
Insulation resistance	Min. 100 MΩ (At 500 V d.c.)				
Dielectric strength	1,500 V a.c. for 1 minute				
Ambient temperature	-15 ~ 45 °C				
Ambient humidity	45 ~ 85 % RH				

■ Suffix code







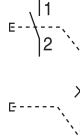
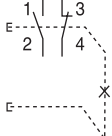

Model	Code	Information
HY-102	<input type="checkbox"/> <input type="checkbox"/> <input type="checkbox"/> <input type="checkbox"/> <input type="checkbox"/> <input type="checkbox"/>	Hoist switch
Lever selection	2	2
	4	4
	6	6
	8	8
	9	9
Emergency button		No
	S	Yes
Switch unit type	A A A A	102A contact unit
	B B B B	102B contact unit
	C C C C	102C contact unit
	D D D D	102D contact unit
	E E E E	102E contact unit
		2 Buttons / unit

※Within the switch unit type, AAAA indication means 4 switch units.

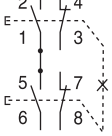

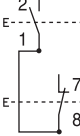
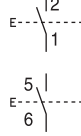
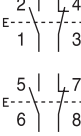
Temperature Controller
Recorder
Digital Counter
Timer
Analog Timer
Panel Meter
Multi Pulse Meter
Proximity Sensor
Photo Sensor
Rotary Encoder
Thyristor Power Regulator
Solid State Relay
Power Supply
Control Switch
Push Button / Main Switch
Cam Switch / Limit Switch
Micro / Hoist Switch
Foot / Mono Lever Switch
Signal Light
Terminal Block / Power Buzzer / Fuse Holder / Control Box

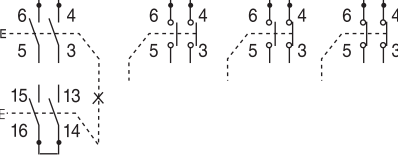
Hoist Switch

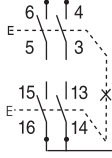
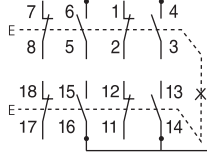
Contact unit

Model	Appearance	Contact composition	Explanation
102 A		<div style="display: flex; justify-content: space-around;"> <div style="text-align: center;"> <p>102A10 (1a)</p>  </div> <div style="text-align: center;"> <p>102A11 (1a1b)</p>  </div> </div>	<p>※ On/Off switch</p> <ul style="list-style-type: none"> Pressing the On button will turn ON the power and self-maintenance will be performed Pressing the Off button will turn OFF the power.
102 B		<div style="display: flex; justify-content: space-around;"> <div style="text-align: center;"> <p>102B20 (1a-1a)</p>  </div> <div style="text-align: center;"> <p>102B22 (1a1b-1a1b)</p>  </div> </div>	<p>※ Up/Down, forward/back, left/right</p> <ul style="list-style-type: none"> This is for the typical circuit. It is a seesaw type so pressing it synchronously is impossible
120 C		<div style="display: flex; justify-content: space-around;"> <div style="text-align: center;"> <p>102C11 (1a-1b)</p>  </div> <div style="text-align: center;"> <p>102C20 (1a-1a)</p>  </div> <div style="text-align: center;"> <p>102C22 (1a1b-1a1b)</p>  </div> </div>	<p>※ Typical circuit</p> <ul style="list-style-type: none"> No mechanical interlock is included, so two buttons can be operated independently.
102 D		<p style="text-align: center;">102D(2a-2a)</p> 	<p>※ 2 stages switch</p> <ul style="list-style-type: none"> Contact separated in 2 stages and operated Velocity controlling, 2 circuits controlling Seesaw type so pressing it synchronously is impossible
102 E		<div style="display: flex; justify-content: space-around;"> <div style="text-align: center;"> <p>102E20 (2a-2a)</p>  </div> <div style="text-align: center;"> <p>102E22 (2a2b-2a2b)</p>  </div> </div>	<p>※ Typical circuit</p> <ul style="list-style-type: none"> Max 2a2b-2a2b, 2a-2b Seesaw type so it is impossible to press it synchronously

Contact unit (Emergency switch)



Model	Appearance	Contact composition	Explanation
102 S			<p>※ Emergency switch (Red) (Push lock-turn reset)</p> <ul style="list-style-type: none"> Cut off the power when pressing the button (becomes self-maintenance) It will return once rotating the button to the printing direction.

※ Mixed returning type is an order-made product so when placing an order please record the returning operation within each channel. Standard contact composition (each direction of product) is 1a

Sign Tower

■ STS series Sign tower



■ Specification

Model	STS 040	STS 060	STS 080
Appearance			
Size	∅ 40	∅ 60	∅ 80
Mount	Plastic round bracket L type bracket Elbow bracket (option)	Plastic round bracket L type bracket Elbow bracket (option)	Plastic round bracket L type bracket Elbow bracket (option)
Rated voltage	24 V d.c., 24 V a.c. (12 V is a custom-made)		
Number of stacks	1, 2, 3, 4, 5 stacks		
Color	Red, Yellow, Green, Blue, White		
Power consumption	Approx. max 6 W for 5 stacks (0.9 W per each lamp)		
Drive	Relay, NPN, PNP Transistor Open Collector Drive		
Material	Heat resistant (ABS)		

■ Suffix code

Model	Code	Information
STS	<input type="checkbox"/> - <input type="checkbox"/> <input type="checkbox"/> <input type="checkbox"/>	Sign tower continuous light
Diameter size	040	∅40 cylinder type
	060	∅60 cylinder type
	080	∅80 cylinder type
Power supply voltage	C51	24 V d.c./a.c. 50 – 60 Hz (dual usage)
	D41	12 V d.c./a.c. 50 – 60 Hz (dual usage)
Module colors	1	1 stack (Red)
	2	2 stack (Red, green)
	3	3 stack (Red, yellow, green)
	4	4 stack (Red, yellow, green, blue)
	5	5 stack (Red, yellow, green, blue, white)
Supporter selection	M	Plastic round supporter (standard)
	L	L type supporter
Optional		Elbow type supporter (EPM)





※ 12 V d.c./a.c. : order made product.

Model	L Type	M Type Plastic round supporter (standard)	EPM Elbow type supporter (OPTION)
Appearance			

Sign Tower

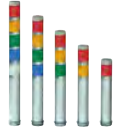
STL series Sign tower

Specification

Model	STL 025	STL 040	STL 060	STL 080
Appearance				
Size	Ø 25	Ø 40	Ø 60	Ø 80
Function	Continuous light only	A : Continuous light F : Continuous light, Flashing light, Buzzer		
Rated voltage	24 V d.c.	24 V d.c./a.c., 100 – 240 V a.c. 50–60 Hz		
Number of stacks	1, 2, 3, 4, 5 stacks			
Drive	Relay, NPN, PNP Transistor Open Collector Drive 24 V d.c. / 24 V a.c.	Relay, NPN, PNP Transistor Open Collector Drive 24 V a.c. / V d.c., 100 – 240 V a.c.		
Mount	L type bracket (ST-AG : sold separately)	Direct Plastic round bracket STM-84 (option), STM-105 (option) Elbow type bracket(EPM) (option)		
Color	Red, Yellow, Green, Blue, White			
Power consumption	approx. max 4 W for 5 stacks (0.6W per each lamp)	approx. max 8 W for 5 stacks (1.2 W per each lamp)		
Buzzer	–	75 dB (1 m)	85 dB (1 m)	



Suffix code

Model	Code	Information
STL	<input type="checkbox"/> - <input type="checkbox"/> <input type="checkbox"/> <input type="checkbox"/> <input type="checkbox"/>	Sign tower
Diameter size	025	Ø25 cylinder type
Power supply voltage	D51	24 V d.c. (LED light source)
Module colors	1	1 stack (Red)
	2	2 stack (Red, green)
	3	3 stack (Red, yellow, green)
	4	4 stack (Red, yellow, green, blue)
	5	5 stack (Red, yellow, green, blue, white)
Supporter selection	N	NPN (Common Anode)
	P	PNP (Common Cathode)

※ Color of modules can be changed at customer's request

※ L type supporter sold separately

Supporter

Model	L Type	M Type Plastic round supporter (standard)	EPM Elbow type supporter (OPTION)
Appearance			

Suffix code

Model	Code	Information
STL	<input type="checkbox"/> - <input type="checkbox"/> <input type="checkbox"/> <input type="checkbox"/> <input type="checkbox"/>	Sign tower (LED light source)
Diameter size	040	Ø40 cylinder type
	060	Ø60 cylinder type
	080	Ø80 cylinder type
Function	A	Continuous light only
	F	Continuous light, flashing light and buzzer (selected by the external signal)
Power supply voltage	C51	24 V d.c./a.c. 50 – 60 Hz (Dual usage)
	A11	100 – 240 V a.c. 50 – 60 Hz
Module colors	1	1 stack (Red)
	2	2 stack (Red, green)
	3	3 stack (Red, yellow, green)
	4	4 stack (Red, yellow green, blue)
	5	5 stack (Red, yellow, green, blue, white)
Supporter selection	D	Direct installation (bolt fixing installation)
	L	L type supporter
	M	Plastic supporter (standard)
Optional		Selecting type supporter (STM)
		Elbow type supporter installation (EPM)

※ Composition of stacking modules : Upper side (1st stack) to the lower side.

■ STA series (Ø25) Sign tower

■ Specification

Model	VOLTAGE	BULB	COLOR
HY-STA-TB-012	12 V a.c. / d.c.	12 V, 2 W	Red,Green
HY-STA-TB-013	12 V a.c. / d.c.	12 V, 2 W	Red,Yellow,Green
HY-STA-TB-014	12 V a.c. / d.c.	12 V, 2 W	Red,Yellow,Green,Blue
HY-STA-TB-022	24 V a.c. / d.c.	24 V, 2 W	Red,Green
HY-STA-TB-023	24 V a.c. / d.c.	24 V, 2 W	Red,Yellow,Green
HY-STA-TB-024	24 V a.c. / d.c.	24 V, 2 W	Red,Yellow,Green,Blue
HY-STA-TB-102	110 V a.c.	110 V, 2 W	Red,Green
HY-STA-TB-103	110 V a.c.	110 V, 2 W	Red,Yellow,Green
HY-STA-TB-104	110 V a.c.	110 V, 2 W	Red,Yellow,Green,Blue
HY-STA-TB-202	220 V a.c.	220 V, 2 W	Red,Green
HY-STA-TB-203	220 V a.c.	220 V, 2 W	Red,Yellow,Green
HY-STA-TB-204	220 V a.c.	220 V, 2 W	Red,Yellow,Green,Blue



■ Suffix code

Model	Code	Information
STA	<input type="checkbox"/> <input type="checkbox"/>	Sign tower (Ø25)
Power supply voltage	01	12 V d.c./a.c.
	02	24 V d.c./a.c.
	10	110 V a.c.
	20	220 V a.c.
Stacking modules	2	2 stack (Red, green)
	3	3 stack (Red, yellow, green)
	4	4 stack (Red, yellow, green, blue)

※ L type supporter sold separately

Temperature Controller
Recorder
Digital Counter Timer
Analog Timer
Panel Meter
Multi Pulse Meter
Proximity Sensor
Photo Sensor
Rotary Encoder
Thyristor Power Regulator
Solid State Relay
Power Supply
Control Switch
Push Button / Main Switch
Cam Switch / Limit Switch
Micro / Hoist Switch
Foot / Mono Lever Switch
Signal Light
Terminal Block / Power Buzzer / Fuse Holder / Control Box

Sign Tower





■ HY-STE series (Ø60) Sign tower

Specification

Base unit specification

Model	STE060-BAD51	STE060-BFD51	STE060-BAA11	STE060-BFA11	Dimension
Power supply voltage	24 V d.c.		100 – 240 V a.c. 50 – 60 Hz		 DC type AC type
Function	Lighting only	Lighting, Flickering, Buzzer (External signal)	Lighting only	Lighting, Flickering, Buzzer (External signal)	
Flickering time	–	60 times / minute	–	60 times / minute	
Buzzer sound types	–	A single melody / beeping	–	A single melody / beeping	
Size of buzzer sound	–	85 dB (1 m distance)	–	85 dB (1 m distance)	
Consumption of electrical power	–	1.2 W	–	1.2 W	
Ambient Temperature/Humidity	–5 °C ~ 50 °C / 35 ~ 85 % RH (with no condensation)				
Weight	76 g	96 g	160 g	178 g	

LED unit specification

Model	STE060-LR	STE060-LY	STE060-LG	STE060-LB	STE060-LW
Dimension					
Power supply voltage	24 V d.c.				
Consumption of electrical power	1.2 W				
Light source	LED				
Emission angle	360 °				
Ambient Temperature/Humidity	–5 °C ~ 50 °C / 35 ~ 85 % RH (with no condensation)				
Weight (g)	43 g				

■ Suffix code

Model	Code	Description
STE060 –	<input type="checkbox"/> <input type="checkbox"/> <input type="checkbox"/> <input type="checkbox"/>	Ø60 LED Light sign tower
Function	A	Lighting only
	F	Lighting, Flickering, Buzzer (External signal)
Power supply voltage	D51	24 V d.c.
	A11	100 – 240 V a.c. 50– 60 Hz
Stacking modules	1	1 stack (Red)
	2	2 stacks (Red, Green)
	3	3 stacks (Red, Yellow, Green)
	4	4 stacks (Red, Yellow, Green, Blue)
	5	5 stacks (Red, Yellow, Green, Blue, White)
Supporter selection	L	L type supporter (Standard type)
	E	Elbow type supporter (EPM-18)
	M	Plastic supporter (MP-60)
	S	Plastic supporter (ST-011)



※ The color was arranged from top to bottom in following order, Red, Yellow, Green, Blue, and White. There are two types of functions which are lightening only / Lightening, Flickering & Buzzer.



■ Base unit suffix code

Model	Code	Description
STE060 –	<input type="checkbox"/> <input type="checkbox"/> <input type="checkbox"/>	STE060 Sign tower base unit
Classification	B	Base unit
Function	A	Lighting only
	F	Lighting, Flickering, Buzzer (External signal)
Power supply voltage	D51	24 V d.c.
	A11	100 – 240 V a.c. 50 – 60 Hz

■ LED unit suffix code



Model	Code	Description
STE060 –	<input type="checkbox"/> <input type="checkbox"/>	STE060 Sign tower LED unit
Classification	L	LED unit
Unit	R	Red unit
	Y	Yellow unit
	G	Green unit
	B	Apua unit
	W	White unit





■ Supporter

Model	L Type	M Type Plastic round supporter (standard)	EPM Elbow type supporter (OPTION)
Appearance			



■ HY-TN series (Ø55) Sign tower

Specification

STAGE	Model	VOLTAGE	CONSUMPTION POWER	BULB	LED
CE  1	HY-TN-24-1 HY-TN-220-1	24 V d.c. 220 V a.c.	0,21 A 0,04 A	5 W	
	HY-TN-24-2 HY-TN-220-2	24 V d.c. 220 V a.c.	0,42 A 0,08 A	5 W	
CE  3	HY-TN-24-3 HY-TN-220-3	24 V d.c. 220 V a.c.	0,63 A 0,11 A	5 W	
	HY-TN-24-4 HY-TN-220-4	24 V d.c. 220 V a.c.	0,84 A 0,14 A	5 W	
CE  4	HY-TN-24-5 HY-TN-220-5	24 V d.c. 220 V a.c.	1,05 A 0,17 A	5 W	

STAGE	Model	VOLTAGE	CONSUMPTION POWER	BULB	LED	FLASHING
CE  1	HY-TWBN-24-1 HY-TWBN-220-1	24 V d.c. 220 V a.c.	0,21 A 0,04 A	5 W		
	HY-TWBLN-24-1 HY-TWBLN-220-1	24 V d.c. 220 V a.c.	48 mA 18 mA		1,2 VA 4 VA	
CE  2	HY-TWBN-24-2 HY-TWBN-220-2	24 V d.c. 220 V a.c.	0,42 A 0,08 A	5 W		
	HY-TWBLN-24-2 HY-TWBLN-220-2	24 V d.c. 220 V a.c.	96 mA 36 mA		1,2 VA 4 VA	
CE  3	HY-TWBN-24-3 HY-TWBN-220-3	24 V d.c. 220 V a.c.	0,63 A 0,11 A	5 W		60 /minute
	HY-TWBLN-24-3 HY-TWBLN-220-3	24 V d.c. 220 V a.c.	144 mA 54 mA		1,2 VA 4 VA	
CE  4	HY-TWBN-24-4 HY-TWBN-220-4	24 V d.c. 220 V a.c.	0,84 A 0,14 A	5 W		
	HY-TWBLN-24-4 HY-TWBLN-220-4	24 V d.c. 220 V a.c.	192 mA 72 mA		1,2 VA 4 VA	
CE  5	HY-TWBN-24-5 HY-TWBN-220-5	24 V d.c. 220 V a.c.	1,05 A 0,17 A	5 W		
	HY-TWBLN-24-5 HY-TWBLN-220-5	24 V d.c. 220 V a.c.	240 mA 90 mA		1,2 VA 4 VA	

Suffix code



Model	Code	Information
HY-	<input type="checkbox"/> <input type="checkbox"/> <input type="checkbox"/> <input type="checkbox"/>	HY-TN series sign tower
Function	TN	Continuous light only
	TWBN	Continuous light, flashing light, buzzer
Power supply voltage	24	24 V d.c.
	220	220 V a.c.
Stacking modules	1	1 stack (Red)
	2	2 stack (Red, green)
	3	3 stack (Red, yellow, green)
	4	4 stack (Red, yellow, green, blue)
	5	5 stack (Red, yellow, green, blue, white)
Supporter selection		No indication (L type supporter standard)
Optional		ST-011 (Plastic bracket installation)
		MP-60 (Plastic bracket installation (Bar type))
		EPM (Plastic elbow type bracket)

Temperature Controller
Recorder
Digital Counter
Timer
Analog Timer
Panel Meter
Multi Pulse Meter
Proximity Sensor
Photo Sensor
Rotary Encoder
Thyristor Power Regulator
Solid State Relay
Power Supply
Control Switch
Push Button / Main Switch
Cam Switch / Limit Switch
Micro / Hoist Switch
Foot / Mono Lever Switch
Signal Light
Terminal Block / Power Buzzer / Fuse Holder / Control Box

Cube Tower

CTB-KBB, CTC-KBM Square pillar type Cube tower (Turn light)

Specification



Model	VOLTAGE	CONSUMPTION POWER	BULB	COLOR	REVOLUTION	
 □ 82 REVOLVING CUBE LIGHT	HY-CTB-KBB-021	24 V d.c.	12 W	24 V, 10 W	Red	160 /minute
	HY-CTB-KBB-022	24 V d.c.	24 W	24 V, 10 W	Red,Green	
	HY-CTB-KBB-023	24 V d.c.	35 W	24 V, 10 W	Red,Yellow,Green	
	HY-CTB-KBB-201	220 V a.c.	8 W	12 V, 5 W	Red	
	HY-CTB-KBB-202	220 V a.c.	16 W	12 V, 5 W	Red,Green	
	HY-CTB-KBB-203	220 V a.c.	23 W	12 V, 5 W	Red,Yellow,Green	
 □ 116 REVOLVING CUBE LIGHT	HY-CTC-KBM-021	24 V d.c.	18 W	24 V, 10 W	Red	130 /minute
	HY-CTC-KBM-022	24 V d.c.	28 W	24 V, 10 W	Red,Green	
	HY-CTC-KBM-023	24 V d.c.	38 W	24 V, 10 W	Red,Yellow,Green	
	HY-CTC-KBM-201	220 V a.c.	13 W	12 V, 5 W	Red	
	HY-CTC-KBM-202	220 V a.c.	18 W	12 V, 5 W	Red,Green	
	HY-CTC-KBM-203	220 V a.c.	23 W	12 V, 5 W	Red,Yellow,Green	

Suffix code

Model	Code	Information
CTB-KBB	□ □	82 mm square pillar type Cube tower (Turn light) (buzzer built in)
CTB-KBM	□ □	116 mm square pillar type Cube tower (Turn light) (4 melody type built in)
Power supply voltage	02	24 V d.c./a.c.
	10	110 V a.c.
	20	220 V a.c.
Stacking modules	1	1 stack (Red)
	2	2 stack (Red, green)
	3	3 stack (Red, yellow, green)

WME series Wall mounted light

Specification

Model	WME
Appearance	 
Function	A : Continuous light F : Continuous light, Flashing light, Buzzer
Body (Color)	B : Beige C : Chrome plating
Rated voltage	24 V d.c., 24 V a.c. (12 V is a custom-made)
Number of stacks	3 stacks basics
Power consumption	2.1 W max
Buzzer	approx 85 dB (1m)
Drive	NPN, PNP Transistor Open Collector Drive 24 V d.c. , 24 V a.c.

Suffix code

Model	Code	Information
WME--	□ □ □	Wall mounted light
Appearance	B	Beige color body
	C	Chrome gold plating body
Function	A	Continuous light indication
	F	Continuous light indication, flashing light indication, buzzer (selected by the external signal)
Power supply voltage	C51	24 V d.c./a.c. 50 - 60 Hz Dual usage
	C41	12 V d.c./a.c. 50 - 60 Hz Dual usage C41 ※optional

Wall Mounted Light

WMS series Wall mounted light

Specification

Model	WMS
Appearance	
Function	A : Continuous light F : Continuous light, Flashing light, Buzzer
Body (Color)	Red, Yellow, Green, Blue, White
Rated voltage	24 V d.c., 24 V a.c. (12 V is a custom-made)
Number of stacks	1, 2, 3, 4, 5 stacks
Power consumption	0.5 W per each lamp, max. 3.2 W for 5 stacks F type
Buzzer	70 dB (1m)
Drive	NPN, PNP Transistor Open Collector Drive 24 V d.c. , 24 V a.c.

Suffix code

Model	Code	Information
WMS-	<input type="checkbox"/> <input type="checkbox"/> <input type="checkbox"/>	Wall mounted light
Appearance	A	Only for continuous light
	F	Continuous light, flashing light, buzzer (selected by the external signal)
Function	C51	24 V d.c./a.c. 50 – 60 Hz Dual usage (Standard specification)
	C41	12 V d.c./a.c. d50 – 60 Hz Dual usage ※ "C41" Order made
Power supply voltage	1	1 stack (Red)
	2	2 stack (Red, Green)
	3	3 stack (Red, Yellow, Green)
	4	4 stack (Red, Yellow, Green, Blue)
	5	5 stack (Red, Yellow, Green, Blue, White)

WT series Turn light

Specification

Model	WT-□C51□	WT-□A11□
Appearance		
Function	Turn Light	Turn Light
Dimension	∅ 100 (Round cap)	
Power supply voltage	24 V d.c. / a.c. 50 – 60 Hz	100 – 240 V a.c. 50 – 60 Hz
Power consumption	3.3 W max.	6 W max.
Revolution	Approx. 180 turn/ 1 min (reflector)	
Light source	Flat type LED (1 W)	
Cap(sensor)material	PC(Polycarbonate)	
Body	Heat resistant ABS copolymer	
Cap color	Red, Yellow, Green	
Environmental operation range	Temperature : -5 ~ 50 °C, Humidity : 35 ~ 85 % RH (Without condensation)	



Suffix code

Model	Code	Information
WT-	<input type="checkbox"/> <input type="checkbox"/> <input type="checkbox"/>	Wall-mounted type LED turn light
Cap shape	P	Round cap
	F	Square cap
Power supply voltage	C51	24 V d.c. / a.c. 50 – 60 Hz
	A11	100 – 240 V a.c. 50 – 60 Hz
Cap color	R	Red
	Y	Yellow
	G	Green

Turn Light

TLB series Turn light

Specification

Model	TLB 060	TLB 100	TLB 150
Appearance			
Size	Ø70	Ø100	Ø140
Shape	P: Round shape lens, Direct mount (Buzzer) R: Round shape lens, Prop mount F: Square shape lens, Direct mount (Buzzer) X: Square shape lens, Prop mount	P: Round shape lens, Direct mount (Buzzer) F: Square shape lens, Direct mount (Buzzer)	F: Square shape lens, Direct mount (Buzzer)
Function	A: Revolution and continuous light F: Revolution and continuous light, Buzzer (Except stainless material)	A: Revolution and continuous light F: Revolution and continuous light, Buzzer (Except stainless material)	A: Revolution and continuous light F: Revolution and continuous light, Buzzer (Except stainless material)
Rated voltage	24 V d.c., 24 V a.c. (12 V is a custom-made)		
Color	Red, Yellow, Green		
Bulb	24 V 5 W	24 V 10 W	24 V 21 W
Buzzer	Approx. 80 dB for code F (1m)	Approx. 90 dB for code F (1m)	Approx. 90 dB (1m)
Power consumption	max 7 W for code C51, max 11 W for code A11	max 12 W for code C51, max 15 W for code A11	max 24 W for code A, max 33 W for code F
Revolutions	approx. 210 revolutions per minute	approx. 170 revolutions per minute	approx. 85 revolutions per minute
Drive	Relay, NPN, PNP Transistor Open Collector Drive		
Material	ABS		

Suffix code (TLB060)

Model	Code	Information
TLB-	<input type="checkbox"/> : <input type="checkbox"/> : <input type="checkbox"/> : <input type="checkbox"/> : <input type="checkbox"/>	Turn light
Dimension	060	Ø70 Cap
Cap shape	P	Round cap direct installation
	F	Rectangular cap direct installation
	R	Round cap support installation
	X	Rectangular cap support installation
Function	A	Rotating continuous light
	F	Rotating continuous light, Buzzer
Power supply voltage	C51	24 V d.c./a.c. 50 – 60 Hz
	A11	100 – 240 V a.c. 50 – 60 Hz
Cap color	R	Red
	Y	Yellow
	G	Green
	B	Blue



※ Optional (Supporter : STM-84 )

※ "F" function selection excluded

※ Cap shape, R, X type excluded

Suffix code (TLB100)

Model	Code	Information
TLB-	<input type="checkbox"/> : <input type="checkbox"/> : <input type="checkbox"/> : <input type="checkbox"/> : <input type="checkbox"/>	Turn light
Dimension	100	Ø100 Dimension
Cap shape	P	Round cap direct installation
	F	Rectangular cap direct installation
Function	A	Rotating continuous light
	F	Rotating continuous light, Buzzer
Power supply voltage	C51	24 V d.c./a.c. 50 – 60 Hz
	A11	100 – 240 V a.c. 50 – 60 Hz
Cap color	R	Red
	Y	Yellow
	G	Green
	B	Blue

※ Optional (Supporter : STM-105  , MTM-98 )







Suffix code (TLB150)

Model	Code	Information
TLB-	<input type="checkbox"/> : <input type="checkbox"/> : <input type="checkbox"/> : <input type="checkbox"/> : <input type="checkbox"/>	Turn light
Dimension	150	Ø140 Cap
Cap shape	F	Rectangular cap direct installation
Function	A	Rotating continuous light
	F	Rotating continuous light, Buzzer (※ Material "S" excluded)
Power supply voltage	C51	24 V d.c./a.c. 50 – 60 Hz
	A11	100 – 240 V a.c. 50 – 60 Hz
Cap color	R	Red
	Y	Yellow
	G	Green
	B	Blue

Turn Light

T series Turn light

Specification

Model	TR-□□	TX-□□	TF-□□	TP-□□	TFB-□□	TPB-□□
Appearance						
Function	Rotating continuous light				Rotating continuous light, buzzer	
Dimension	Round type cap supporter attachment	Rectangular type cap supporter attachment	Rectangular type cap direct attachment	Round type cap direct attachment	Rectangular type cap direct attachment	Round type cap direct attachment
Power supply voltage	12 V d.c., 24 V d.c., 110/220 V a.c., 50/60 Hz					
Current consumption	0.9 A (When power supply voltage is 12 V d.c.), 0.5 A (When power supply voltage is 24 V d.c.) 0.1 A (When power supply voltage is 110 V d.c.), 0.05 A (When power supply voltage is 240 V d.c.)					
Rotating speed	Approx 130 tome/min					
Light source	Incandescent lamp (BA 15S)					
Lamp capacity	12 V 5 W (When power supply voltage is 12 V d.c.), 24 V 5W (When power supply voltage is 24 V d.c.) 12 V 5 W (When power supply voltage is 110/220 V d.c.)					
Buzzer volume	-				Approx 80 dB	
Cap material	Polycarbonate (PC) resin					
Body	ABS resin					
Lens color	Red, Yellow, Green, Blue					
Degree of protection	IP54					

Suffix code

Model	Code	Information
Dimension and function	□ □ □	Turn light (∅84)
	TR	Round type cap supporter attaching installation
	TX	Rectangular type cap supporter attaching installation
	TF	Rectangular type cap direct installation
	TP	Round type cap direct installation
	TFB	Rectangular type cap direct installation
Power supply voltage	12	12 V d.c.
	24	24 V d.c.
	012	110/220 V a.c. 50 / 60 Hz
Cap color	R	Red
	Y	Yellow
	G	Green
	B	Blue

Turn Light

■ RLA-KB/KBB Turn light

■ Specification

Model	RLA-KB□	RLA-KBB□□
Appearance		
Function	Rotating continuous light	Rotating continuous light, buzzer
Dimension	Ø118 Cap	
Power supply voltage	12 V d.c., 24 V d.c., 110/220 V a.c. 50/60 Hz	
Power consumption	4.0 W (when power supply voltage is 24 V d.c.), 4.5 W (when power voltage is 220 V a.c.)	
Rotating speed	Approx 80 times/min	
Light source	Incandescent lamp (base rating : BA 15S)	
Buzzer volume	-	Approx 90 dB
Material	Cap: acryl resin, Body : ABS resin	
Cap color	Red, Yellow, Green	
Degree of protection	IP54	

■ Suffix code

Model	Code	Information
RLA-	□ □ □	Turn light (Ø118)
Appearance	KB	Rotating continuous light
	KBB	Rotating continuous light and buzzer built in
Power supply voltage and installation method	01	12 V d.c.
	02	24 V d.c.
	012	110 / 220 V a.c.
	012M	110 / 220 V a.c.
	01A	12 V d.c.
	02A	24 V d.c.
Cap color	R	Red
	Y	Yellow
	G	Green

■ RLA-WX/WXB Signal light(XENON lamp)

■ Specification

Model	RLA-WX□□	RLA-WXB□□
Appearance		
Function	Strobe only	Strobe, Buzzer
Dimension	Ø118 rectangular cap (Direct installation, Magnet attachment type supporter, Magnet attachment type supporter and cigar jack)	
Power supply voltage	12 V d.c., 24 V d.c., 110 V a.c., 220 V a.c. 50/60 Hz, Selected by the suffix code	
Power consumption	7.2 W (when power supply voltage is 24 V d.c.), 12 W (when power supply voltage is 220 V a.c.)	
Strobe speed	Approx. 60 times/min	
Light source	Xenon tube Strobe light	
Buzzer	-	Buzzer built in (approx 90 dB from distance 1 m)
Material	Cap : acryl resin, Body : ABS resin	
Cap color	Red, Blue, White	
Degree of protection	IP54	



■ Suffix code

Model	Code	Information
RLA-	□ □ □	Signal light (XENON Lamp)
Function	WX	Strobe light
	WXB	Strobe light and buzzer built in type
Power supply voltage and installation method	01	12 V d.c.
	02	24 V d.c.
	10	110 V a.c.
	20	220 V a.c.
	10M	110 V a.c.
	20M	220 V a.c.
	01A	12 V d.c.
	02A	24 V d.c.
Cap color	R	Red
	Y	Yellow
	B	Blue

Warning Light

LT series Signal light

Specification

Appearance	Suffix code	Power voltage	Power consumption	Number of leds	Revolution	Flickering
	LT-R-12	12 – 24 V a.c. / d.c.	2.9 W max.	24	approx. 90 times for a minutes	approx. 50 times for a minutes
	LT-R-012	110 – 220 V a.c. / d.c.	5 W max.	24		
	LT-P-12	12 – 24 V d.c.	2.9 W max.	24		
	LT-P-012	110 – 220 V a.c.	5 W max.	24		
	LT-PB-12	12 – 24 V d.c.	2.9 W max.	24		
	LT-PB-012	110 – 220 V a.c.	5 W max.	24		

Suffix code

Model	Code	Information
LT-	<input type="checkbox"/> <input type="checkbox"/> <input type="checkbox"/>	Signal light (Ø84 Cap)
Installation type (Function)	R	Supporter mounting (rotating, flashing)
	P	Direct mounting (rotating, flashing)
	PB	Direct mounting (rotating, flashing, buzzer built in)
		※ Optional supporter (STM-105)
Power supply voltage	12	12 - 48 V d.c., 12 - 24 V a.c. 50 – 60 Hz
	012	110/220 V a.c. 50 – 60 Hz
Cap color	R	Red
	Y	Yellow
	G	Green
	B	Blue

SLB series Signal light

Specification

Model	SLB 060
Appearance	
Dimension	Ø70 CAP
Shape	P: Round shape lens, Direct mount (Buzzer), R: Round shape lens, Prop mount F: Square shape lens, Direct mount (Buzzer), X: Square shape lens, Prop mount
Function	A: Continuous light F: Continuous light, Flashing light, Buzzer
Rated voltage	24 V d.c., 24 V a.c. (12 V is a custom-made)
Color	Red, Yellow, Green
Light	LED
Drive	NPN, PNP Transistor Open Collector 24 V a.c./d.c.
Power consumption	max. 1 W
Buzzer	75 ~ 85 dB (1m)





Suffix code

Model	Code	Information
SLB	<input type="checkbox"/> <input type="checkbox"/> <input type="checkbox"/> <input type="checkbox"/>	Turn light
Dimension	060	Ø70 Cap
Design and function	RA	Round type cap supporter mounting installation
	XA	Rectangular type cap supporter mounting installation
	PA	Round type cap direct installation
	FA	Rectangular type cap direct installation
	PF	Round type cap direct installation
	FF	Rectangular type cap direct installation
		Only for Continuous light
Power supply voltage	C51	24 V d.c./a.c. 50 – 60 Hz
	C41	12 V d.c./a.c. 50 – 60 Hz (※ Order-made)
	A11	110 – 240 V a.c. 50 – 60 Hz
Cap color	R	Red
	Y	Yellow
	G	Green

Terminal Blocks & The Others

■ HY-256/306/606/606N Power buzzer

■ Specification



Model	HY-256	HY-306	HY-606	HY-606N
Appearance				
Voltage	110 V, 220 V a.c./d.c. 12 V, 24 V d.c.			
Power consumption	4 VA : HY-256-1, HY-256-2, HY-306-1, HY-306-2 30 mA : HY-256-12, HY-256-24, HY-306-12, HY-306-24		8 VA : HY-606-1, HY-606N-1, HY-606-2, HY-606N-2 30 mA : HY-606-12, HY-606N-2, HY-606-24, HY-606N-24	
Cycle	50 / 60 Hz			
Volume(distance 1m)	85 dB			
External diameter	∅ 25	∅ 30	∅ 65	Exposure type

■ Suffix code

Model	Code	Information
HY-	<input type="checkbox"/> <input type="checkbox"/>	Power Buzzer
Dimension	256	For ∅25
	306	For ∅30
	606	Rectangular panel flush type (For ∅66)
	606N	Rectangular panel extended type (□80)
Voltage	1	110 V a.c., 50/60 Hz
	2	220 V a.c., 50/60 Hz
	12	12 d.c.
	24	24 d.c.

■ HY-606MD/MA 4 tones melody buzzer

■ Specification



Model	HY-606MD	HY-606MA
Appearance		
Voltage	12 / 24 V d.c.	110 / 220 V a.c.
Power consumption	2.5 W	
Frequency	-	50 / 60 Hz
Volume (distance 1m)	98 dB max	
Diameter	∅ 66	

■ Suffix code

Model	Code	Information
HY-606	<input type="checkbox"/>	4 tones melody buzzer
Dimension	MD	12 / 24 V d.c.
	MA	110 / 240 V a.c.

■ HY-226M/256M 3 tones electronic buzzer

■ Specification

Model	HY-226MD,MA	HY-256MD,MA
Appearance		
Voltage	100 - 240 V a.c./ 12, 24 V d.c.	
Power consumption	0.6 W / 13.5 W	
Frequency	50/60 Hz	
Volume(distance 1m)	80 dB	
Diameter	∅ 22/∅ 25	∅ 25







■ Suffix code

Model	Code	Information
HY-	<input type="checkbox"/> <input type="checkbox"/>	3 tones electronic buzzer
Dimension	226	∅22 / ∅25 dual usage (Front side : rectangular type)
	256	For ∅25 installation (Front side : round type)
Voltage	MD	12 - 24 V d.c./a.c.
	MA	100 - 240 V a.c.

Terminal Blocks & The Others

■ HYBT series Assembling terminal block

■ Specification





Model Classification	HYBT-10A	HYBT-15A	HYBT-15A2	HYBT-25A	HYBT-35A	HYBT-60A	HYBT-100A
							
Rated Insulating voltage	Max. 600 V						
Rated current	10A	15A	15A, □□	25A	35A	60A	100A
Insulation resistance	Min. 100 MΩ						
Dielectric strength	2,500 V a.c. for 1minute between non-current carrying parts						
Terminal bolt	M3	M3,5	M3,5	M4	M4	M6	M6
Ambient temperature	-20 ~ 55 °C						
Ambient humidity	45 ~ 85 % RH						

■ Accessory

■ Applying accessories classification

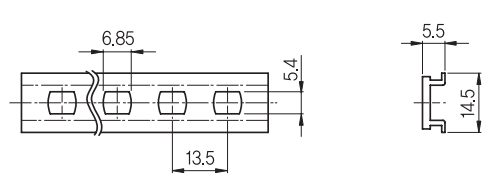

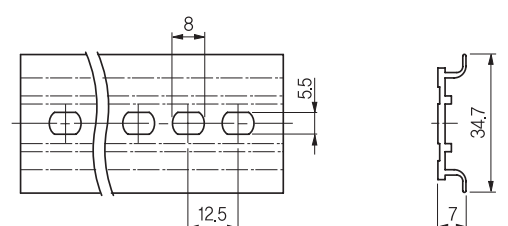
Model	HYBT-10A	HYBT-15A HYBT-15A2	HYBT-25A	HYBT-35A	HYBT-60A	HYBT-100A	
Rail	HYBT-CH10	HYBT-01					
Separator	HYBT-SP10	HYBT-02 HYBT-12	HYBT-03	HYBT-04	HYBT-05	HYBT-06	
Stopper	HYBT-ST10	HYBT-07					
Terminal cover	HYBT-CV10	HYBT-08			HYBT-09		
Number plate	NBT-03	HYBT-10	HYBT-11				
Short terminal	-	HYBT-13	-	-	-	-	

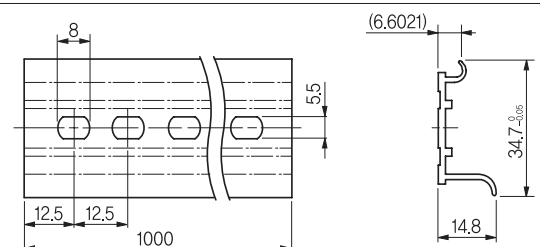
■ Aluminum rail (DIN Rail)

Appearance	Dimension
 <p>HYBT-CH10 (10A)</p>	
 <p>HYBT-01 (15A ~ 100A)</p>	
 <p>HYBT-01A (15 A ~ 100 A for slant purpose)</p>	

Terminal Blocks & The Others

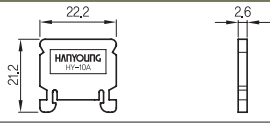
■ Separator

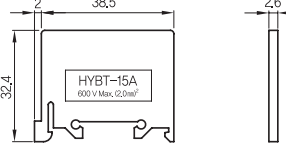
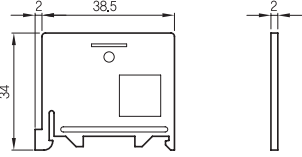
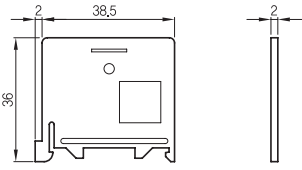
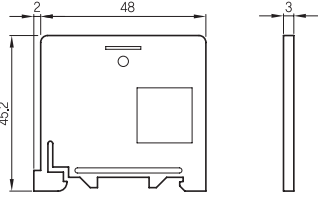
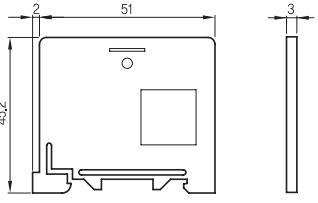

Model	Appearance	Dimension
HYBT-SP10 (10A)		
HYBT-02 (15A)		
HYBT-03 (25A)		
HYBT-04 (35A)		
HYBT-05 (60A)		
HYBT-06 (100A)		

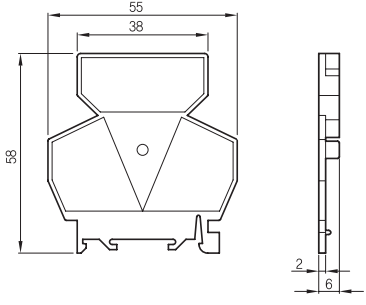
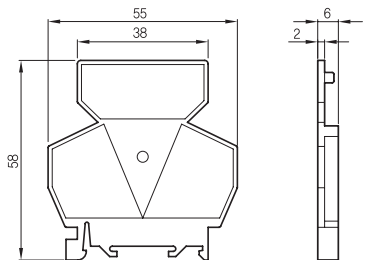
■ Separator



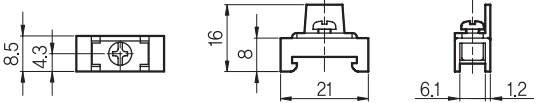

Model	Appearance	Dimension
HYBT-12 (HYBT-15A2-A)		
HYBT-12 (HYBT-15A2-B)		

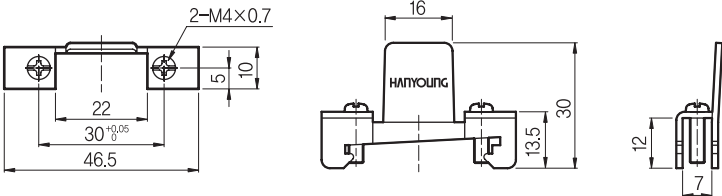
Terminal Blocks & The Others

■ Stopper

Model	Appearance	Dimension
HYBT-ST10		
HYBT07		



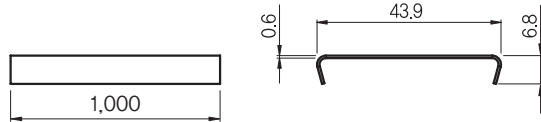

■ Terminal cover

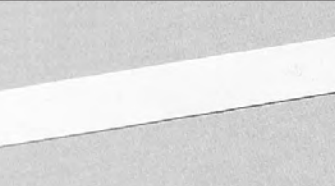
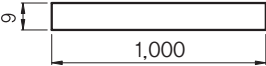
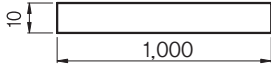
Model	Appearance	Dimension
HYBT-CV10		
HYBT-08		
HYBT-09		

■ Number plate (Seal)

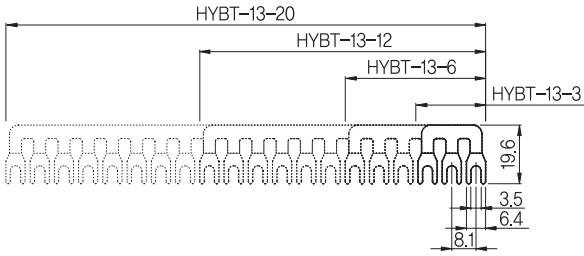
Model	Appearance	Dimension
HYBT10 (9 mm□)		
HYBT11 (10 mm□)		

■ Short Bar

Appearance	Dimension
 HYBT-13-3	
 HYBT-13-6	
 HYBT-13-12	
 HYBT-13-20	

※ Short bar HYBT-13-3~13-20 are only for the HYBT-15A

Temperature Controller
Recorder
Digital Counter Timer
Analog Timer
Panel Meter
Multi Pulse Meter
Proximity Sensor
Photo Sensor
Rotary Encoder
Thyristor Power Regulator
Solid State Relay
Power Supply
Control Switch
Push Button / Main Switch
Cam Switch / Limit Switch
Micro / Hoist Switch
Foot / Mono Lever Switch
Signal Light
Terminal Block / Power Buzzer / Fuse Holder / Control Box

Terminal Blocks & The Others

■ HYT series Fixing type terminal block

■ Rated current 10A

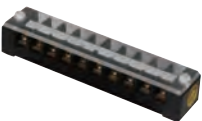
Model	Appearance	Rating	Length	Width	Height	Fixed dimension
HYT-1010		10A 10P	112	24	17	102.5

■ Rated current 20 A

Model	Appearance	Rating	Length	Width	Height	Fixed dimension
HYT-203		20A 3P	56	30	20	44
HYT-204		20A 4P	68	30	20	56
HYT-206		20A 6P	89	30	20	78
HYT-2010		20A 10P	137	30	20	126
HYT-2012		20A 12P	163	30	20	150.5
HYT-2015		20A 15P	199	30	20	187
HYT-2020		20A 20P	257	30	20	245

■ Rated current 30 A

Model	Appearance	Rating	Length	Width	Height	Fixed dimension
HYT-303		30A 3P	67	5	24	54.5
HYT-304		30A 4P	83	35	24	70
HYT-306		30A 6P	113	35	24	100.5
HYT-3010		30A 10P	153	35	24	143

■ Rated current 60 A

Model	Appearance	Rating	Length	Width	Height	Fixed dimension
HYT-603		60A 3P	84.5	40	31	28
HYT-604		60A 4P	113.5	40	31	57

■ Rated current 100 A

Model	Appearance	Rating	Length	Width	Height	Fixed dimension
HYT-1003		100A 3P	104.5	55.5	36.5	35
HYT-1004		100A 4P	140	55.5	36.5	70

■ Rated current 150 A

Model	Appearance	Rating	Length	Width	Height	Fixed dimension
HYT-1503		150A 3P	115.5	67.5	41	39
HYT-1504		150A 4P	153	67.5	41	77

Terminal Blocks & The Others

■ Rated current 200 A

Model	Appearance	Rating	Length	Width	Height	Fixed dimension
HYT-2003		200A 3P	134	72.5	44.5	45
HYT-2004		200A 4P	180	72.5	44.5	90

■ Rated current 300 A

Model	Appearance	Rating	Length	Width	Height	Fixed dimension
HYT-3003		300A 3P	155.5	83.5	49.5	51.8
HYT-3004		300A 4P	207.5	83.5	49.5	103.6

■ Rated current 400 A





Model	Appearance	Rating	Length	Width	Height	Fixed dimension
HYT-4003		400A 3P	155.5	83.5	49.5	51.8
HYT-4004		400A 4P	207.5	83.5	49.5	103.6

■ Rated current 500 A

Model	Appearance	Rating	Length	Width	Height	Fixed dimension
HYT-5003		500A 3P	204	94	59.5	68
HYT-5004		500A 4P	270	93	59.5	136

■ HY-F15 series / HY-F30 series Fuse holder

■ Specification

Model	F15-1A	F15-1D	F15-2A	F15-2D	F15-3A	F15-3D	F30
Appearance							
Rating	250 V a.c. 15 A	24 V d.c. 10 A	250 V a.c. 15 A	24 V d.c. 10 A	250 V a.c. 15 A	24 V d.c. 10 A	250 V a.c. 30 A
Remark	For AC :Common to 110 – 220 V a.c. For DC :Common to 12 – 24 V d.c. ※Use a ceramic fuse						110 – 600 V a.c. ※Ceramic Fuse

Terminal Blocks & The Others

■ HY-25/30 series Rolled iron control box

Specification

Appearance	Model	Material	Remark
	HY-2501	Heat resistant ABS resin	Ø25
	HY-2502		
	HY-2503		
	HY-2504		
	HY-2505		
	HY-2506		
	HY-3001	Heat resistant ABS resin	Ø30
	HY-3002		
	HY-3003		
	HY-3004		
	HY-3005		
	HY-3006		

■ Suffix code

Model	Code	Information
HY-	<input type="checkbox"/> <input type="checkbox"/>	Rolled iron control box
Installation hole	25	Ø25 Installation hole
	30	Ø30 Installation hole
Number of holes	01	1
	02	2 (03 :3, 04 :4, 05 : 5, 06 : 6)

■ HYC-M1/M2 series Cable connector

Specification

Appearance	Model	Material	Remark
	HYC-M1	PC (resin)	Ø8
	HYC-M2	PC (resin)	Ø11

Always with our customers

www.hynux.com



nux
HANYOUNG



Control Switch

Control Instrument

Photo Sensor / Proximity Sensor

Thyristor Power Regulator

Sign tower / Signal light

World Leader in Control & Measurement

MAIN PRODUCTS

Temperature Controller / Recorder / Digital Counter / Timer / Analog Timer / Panelmeter / Multi Pulse Meter
Sensor / Rotary Encoder / Thyristor Power Regulator / Solid State Relay / Power Supply / Control Switch
Hoist Switch / Foot Switch / Mono Lever Switch / Micro Switch / Power Switch / Limit Switch / Cam Switch
Main Switch / Sign Tower / Signal Light / Buzzer / Terminal Block / Fuse Holder / Control Box / Cable Connector

HANYOUNG nux

ADDRESS : 28, Gilpa-ro 71beon-gil, Nam-gu, Incheon, 22121 Korea
T E L : +82-32-876-4697 FAX : +82-32-876-4696
E-mail : overseas@hynux.com

HANYOUNG NUX

MAIN PRODUCTS

Temperature controller / Recorder / Counter / Timer / Panelmeter / Multi pulse meter / Proximity sensor / Photo sensor / Rotary encoder / Thyristor power regulator /
Solid state relay / Power supply / Control switch / Combination display light / Power switch / Main switch / Cam switch / Limit switch / Micro switch / Hoist switch /
Foot switch / Mono lever switch / Sign tower / Turn light / Buzzer / Terminal block / Fuse holder / Control box / Cable connector

HANYOUNG NUX

HANYOUNG NUX CO.,LTD.

28, Gilpa-ro 71 beon-gil, Nam-gu, Incheon, Korea
Tel : +82-32-876-4697 Fax : +82-32-876-4696
E-mail : overseas@hynux.com

